



NUMBER	GS-20-035	TYPE	APPLICATION SPECIFICATION		
TITLE	AirMax VS [®] Connector System, press-fit products (r/a header, r/a receptacle, vertical header, vertical receptacle & orthogonal assemblies)			PAGE	1 of 33
				REVISION	J
				AUTHORIZED BY	Tan Chen Hong
				DATE	18 Aug 09
				STATUS	UNRESTRICTED

TABLE OF CONTENTS

<u>Section</u>	<u>page no.</u>
1. OBJECTIVE.....	2
2. SCOPE.....	2
3. APPLICABLE DOCUMENTS.....	3
4. GENERAL CUSTOMER INFORMATION	3
4.1. CONNECTOR CONFIGURATIONS	3
4.2. COMPATIBILITY WITH HARD METRIC PRODUCTS:.....	7
4.3. CONTACT WIPE DISTANCES:.....	8
4.4. SIGNAL CONNECTOR GUIDING FEATURES:.....	9
4.5. SEPARATE GUIDE MODULES:.....	10
4.6. OPTIONAL SHORT DETECT PIN:.....	10
5. REQUIREMENTS FOR CUSTOMER PCB LAYOUT	11
5.1. HEADER END WALL OPTION	11
5.2. DIFFERENTIAL PAIR vs. SINGLE-ENDED LAYOUTS	12
5.3. PIN ASSIGNMENTS FOR ORTHOGONAL HEADER FOOTPRINTS.....	12
5.4. PCB TRACE ROUTING	13
5.4.1. 2mm pitch between adjacent columns	13
5.4.2. 3mm pitch between adjacent columns	14
5.4.3. Orthogonal, 4.2 mm pitch between adjacent columns.....	15
5.5. PRINTED CIRCUIT BOARD THICKNESS	16
5.6. BACKDRILLING GUIDELINES:.....	17
5.7. PCB SCREEN PRINTING RECOMMENDATIONS:.....	17
5.8. KEEP-OUT ZONES FOR APPLICATION AND REMOVAL TOOLING:.....	17
6. APPLICATION TOOLING	18
6.1. RIGHT ANGLE HEADER (150 position shown)	18
6.2. VERTICAL HEADER (150 position shown)	19
6.3. RIGHT ANGLE RECEPTACLE (150 position shown)	20
6.4. VERTICAL RECEPTACLE (150 position shown).....	21
6.5. CUSTOM TOOLING	22
6.6. INSERTION PRESSES	22
6.6.1. Considerations when specifying a press.....	22
6.6.2. FCI Insertion press specifications	23
7. APPLICATION PROCEDURE	24
7.1. RIGHT ANGLE HEADER & RECEPTACLE (150 position shown)	24
7.2. VERTICAL HEADER & RECEPTACLE (150 position shown)	25
7.3. RECOMMENDED INSERTION FORCES	27
8. POST-APPLICATION INSPECTION REQUIREMENTS	29
9. CONNECTOR REMOVAL TOOLING	32

NUMBER	GS-20-035	TYPE	APPLICATION SPECIFICATION		
TITLE	AirMax VS [®] Connector System, press-fit products (r/a header, r/a receptacle, vertical header, vertical receptacle & orthogonal assemblies)			PAGE	2 of 33
				REVISION	J
				AUTHORIZED BY	Tan Chen Hong
				DATE	18 Aug 09
				STATUS	UNRESTRICTED

1. OBJECTIVE

This specification provides information and requirements for customer application of the AirMax VS[®] press-fit connectors including right angle headers, vertical headers, right angle receptacles, vertical receptacles and orthogonal headers and receptacles. It is intended to provide general guidance for process development. It should be recognized that no single process will work under all customer applications and that customers should develop processes to meet individual needs. However, if the processes vary from the recommended one, FCI cannot guarantee acceptable results.

2. SCOPE

This specification provides information and requirements regarding application of AirMax VS[®] press-fit headers and receptacles to printed circuit boards (PCB).

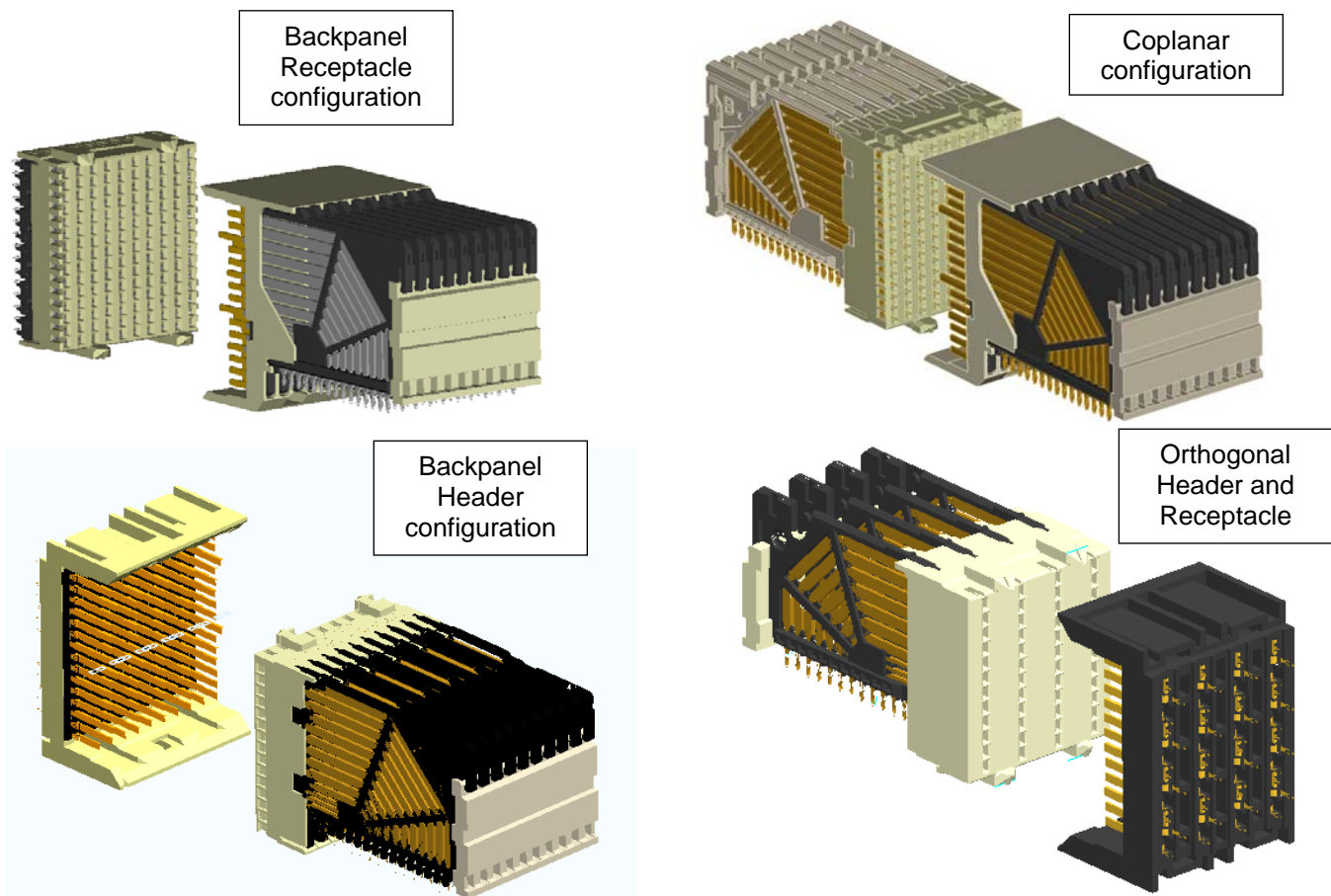



Figure 1: AirMax VS[®] signal connectors

NUMBER	GS-20-035	TYPE	APPLICATION SPECIFICATION		
TITLE	AirMax VS [®] Connector System, press-fit products (r/a header, r/a receptacle, vertical header, vertical receptacle & orthogonal assemblies)			PAGE	3 of 33
				REVISION	J
				AUTHORIZED BY	Tan Chen Hong
		STATUS	UNRESTRICTED		

3. APPLICABLE DOCUMENTS

- Applicable FCI product customer drawings
- FCI Product Specification GS-12-239 (AirMax VS[®] Connector System, press-fit products)
- FCI repair manuals 430294-001 and 430284-001
- FCI Product Specification GS-12-220 (2mm High Power Connector System)
- FCI Application Specification GS-20-023 (2mm High Power Connector System)
- FCI Application Specification GS-20-045 (Hard Metric Guide Connectors)

FCI product drawings and specifications are available by accessing the FCI website or by contacting FCI Technical Service. In the event of a conflict between this specification and the product drawing, the drawing takes precedence. Customers should refer to the latest revision level of FCI product drawings for appropriate product details.

4. GENERAL CUSTOMER INFORMATION

This document is a general application guide. If there is a conflict between the product drawings and this specification, the drawings take precedence.

4.1. CONNECTOR CONFIGURATIONS

AirMax VS[®] press-fit headers are offered in 150, 120, 96, 90, 72, and 54-position right angle configurations with or without end walls. The AirMax VS[®] press-fit orthogonal header and receptacle are available in a 48-position configuration without end walls. Compliant press-fit tails provide a reliable electrical connection between the AirMax VS[®] connectors and the plated through hole (PTH) of the PCB. Press-fit tails eliminate the need for soldering processing of through-board solder tails. Press-fit technology simplifies rework of assembled boards by allowing a damaged connector to be removed and replaced. Each connector may be replaced with a new connector 2 times without damaging the PCB.

The module width of each offering is determined by the pitch between adjacent columns, the number of columns, and whether the header has end walls or not (refer to Table 1). The end walls add mechanical protection for the mating pins but reduce signal density (refer to section 5.1).

NUMBER GS-20-035	TYPE APPLICATION SPECIFICATION		
TITLE AirMax VS [®] Connector System, press-fit products (r/a header, r/a receptacle, vertical header, vertical receptacle & orthogonal assemblies)		PAGE 4 of 33	REVISION J
		AUTHORIZED BY Tan Chen Hong	DATE 18 Aug 09
		STATUS UNRESTRICTED	

Right angle header type (diff pairs per column)	Column pitch	Number of columns	End wall configuration	Module width, mm
150 position (5 pair)	2mm	10	2 wall	20
			4 wall	22
	3mm	10	2 wall	30
			4 wall	32
120 position (5 pair)	2mm	8	2 wall	16
			4 wall	18
	3mm	8	2 wall	24
			4 wall	26
120 position (4 pair)	2mm	10	2 wall	20
			4 wall	22
	3mm	10	2 wall	30
			4 wall	32
96 position (4 pair)	2mm	8	2 wall	16
			4 wall	18
90 position (3 pair)	2mm	10	2 wall	20
			4 wall	22
72 position (4 pair)	2mm*	6*	2 wall	12
			4 wall	14
72 position (3 pair)	2mm	8	2 wall	16
			4 wall	18
54 position (3 pair)	2mm	6	2 wall	12
			4 wall	14

* The coplanar option is not yet available in these configurations

Vertical header type (diff pairs per column)	Column pitch	Number of columns	End wall configuration	Module width, mm
150 position (5 pair)	2mm	10	2 wall	20
	3mm	10	2 wall	30
			4 wall	32
120 position (5 pair)	2mm	8	2 wall	16
120 position (4 pair)	2mm	10	2 wall	20
			4 wall	22
	3mm	10	2 wall	30
			4 wall	32
96 position (4 pair)	2mm	8	2 wall	16
	3mm		2 wall	24
90 position (3 pair)	2mm	10	2 wall	22
			4 wall	24
54 position (3 pair)	2mm	6	2 wall	12

Orthogonal header type (diff pairs per column)	Column pitch	Number of columns	End wall configuration	Module width, mm
48 position (4 pair)	4.2mm	4	2 wall	16.6

Table 1: module widths for each AirMax VS[®] connector offering

NUMBER	GS-20-035	TYPE	APPLICATION SPECIFICATION		
TITLE	AirMax VS [®] Connector System, press-fit products (r/a header, r/a receptacle, vertical header, vertical receptacle & orthogonal assemblies)			PAGE	5 of 33
				REVISION	J
			AUTHORIZED BY	DATE	Tan Chen Hong 18 Aug 09
			STATUS	UNRESTRICTED	

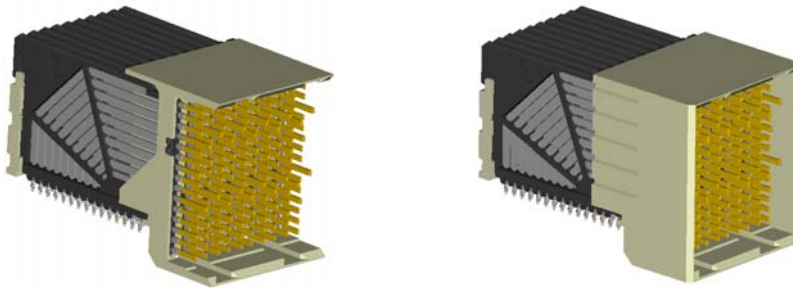

Figure 2: right angle header assembly - 5 pair / 2mm pitch / 10 column versions shown



Figure 3: vertical header assembly - 4 pair / 2mm pitch / 10 column versions shown

AirMax VS[®] vertical receptacles are offered in 150, 120, 96, 90, 72, and 54-position configurations. The same receptacle will mate to any header with the same number of positions and the same number of rows. The module width for a receptacle assembly will be the same as the mating header without end walls.

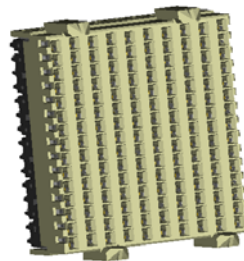



Figure 4: vertical receptacle assembly - 5 pair / 2mm pitch / 10 column version shown

AirMax VS[®] right angle receptacles are offered in 150, 120, 96, and 54-position configurations. The same receptacle will mate to any header with the same number of positions and the same number of rows. The module width for a receptacle assembly will be the same as the mating header without end walls.

NUMBER	GS-20-035	TYPE	APPLICATION SPECIFICATION				
TITLE	AirMax VS [®] Connector System, press-fit products (r/a header, r/a receptacle, vertical header, vertical receptacle & orthogonal assemblies)			PAGE	6 of 33	REVISION	J
				AUTHORIZED BY	Tan Chen Hong	DATE	18 Aug 09
				STATUS	UNRESTRICTED		

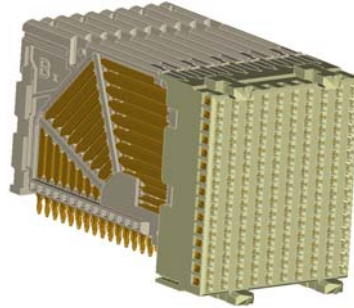

Figure 5: right angle receptacle assembly - 5 pair / 2mm pitch / 10 column version shown

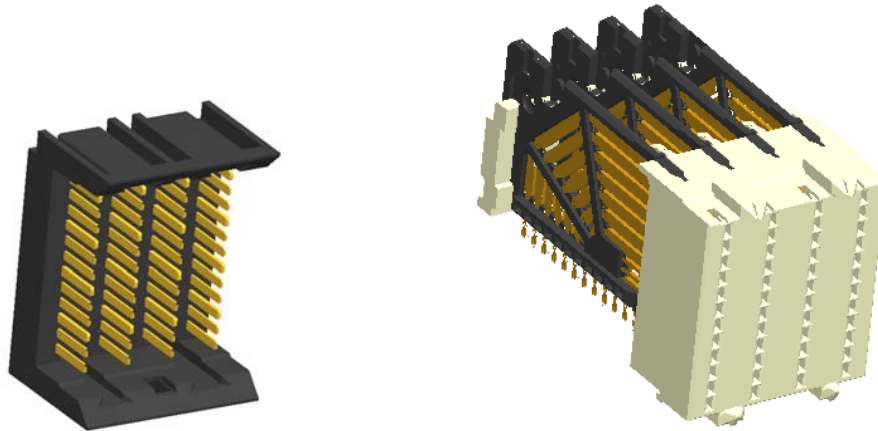



Figure 6: orthogonal header and receptacle – 4-pair / 4.2mm pitch / 4 column

NUMBER GS-20-035	TYPE APPLICATION SPECIFICATION		
TITLE AirMax VS [®] Connector System, press-fit products (r/a header, r/a receptacle, vertical header, vertical receptacle & orthogonal assemblies)		PAGE 7 of 33	REVISION J
		AUTHORIZED BY Tan Chen Hong	DATE 18 Aug 09
		STATUS UNRESTRICTED	

4.2. COMPATIBILITY WITH HARD METRIC PRODUCTS:

The AirMax VS[®] Connector System signal module is compatible with hard metric standards in that the distance between the backplane and front edge of the daughter card in backpanel applications is 12.5mm. For coplanar applications the distance between cards is 12.5mm. See Figures 7 and 8 and Tables 2 thru 4 for dimensions relative to daughter card for various connector types.

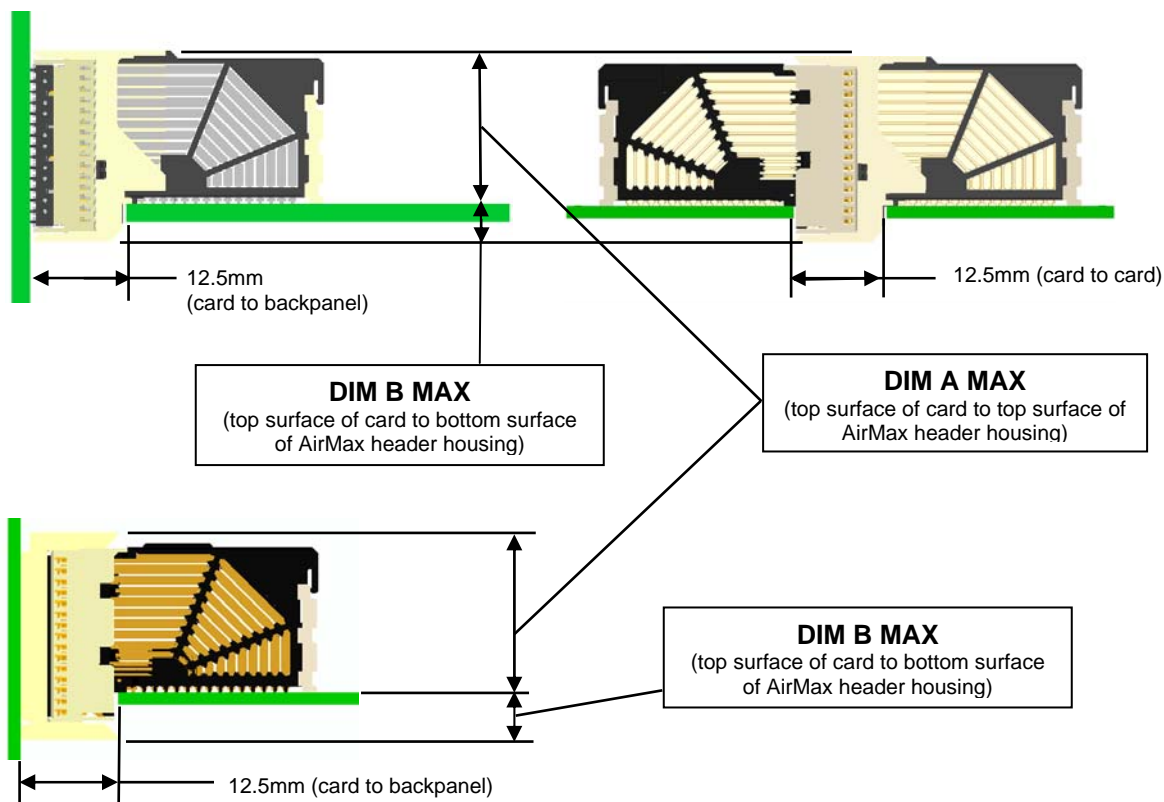

Figure 7: end view of the AirMax VS[®] Connector System (5 pair connectors shown)

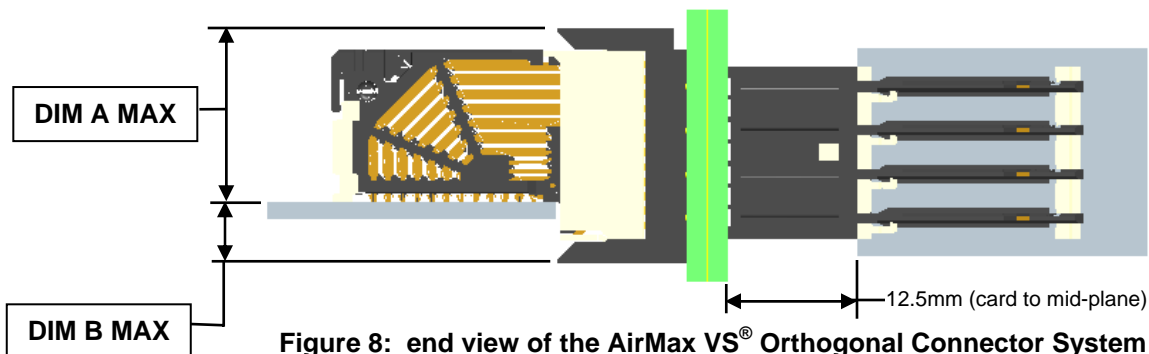



Figure 8: end view of the AirMax VS[®] Orthogonal Connector System

NUMBER	GS-20-035	TYPE	APPLICATION SPECIFICATION		
TITLE	AirMax VS [®] Connector System, press-fit products (r/a header, r/a receptacle, vertical header, vertical receptacle & orthogonal assemblies)			PAGE	8 of 33
				REVISION	J
				AUTHORIZED BY	Tan Chen Hong
				DATE	18 Aug 09
				STATUS	UNRESTRICTED

Connector type	Minimum pitch between adjacent daughter cards, mm	DIM A MAX, mm	DIM B MAX, mm
5 pair	25.0 mm	20.0	5.0
4 pair	20.0 mm	15.4	4.6
3 pair	16.6 mm	11.6	5.0

Table 2: Connector dimensions relative to the daughter card (backpanel receptacle & coplanar)

Connector type	Minimum pitch between adjacent daughter cards, mm		DIM A, mm		DIM B, mm	
	Wide Body	Narrow Body	Wide Body	Narrow Body	Wide Body	Narrow Body
5 pair	26.9	25.0	20.95	20.0	5.95	5.0
4 pair	22.7	20.8	16.75	15.8	5.95	5.0
3 Pair	18.5	16.6	12.55	11.6	5.95	5.0

Table 3: Connector dimensions relative to the daughter card (backpanel header)

Connector type	Minimum pitch between adjacent daughter cards, mm	DIM A MAX, mm	DIM B MAX, mm
4 pair	16.6 mm	16.75	5.95

Table 4: Connector dimensions relative to the daughter card (Orthogonal header)

4.3. CONTACT WIPE DISTANCES:

The table below shows NOMINAL contact wipe distances for backpanel and coplanar product configurations. All values are at full normal force and do not include lead-in geometry on either mating half. All values assume there is no gap between connector mating faces. Please contact FCI Engineering for tolerance information needed to calculate minimum contact wipe.

Product configuration	Advance mate pins (typically assigned as GROUND)	Secondary mating pins**	Optional short detect pin*
Backpanel receptacle	4.0	2.3	1.8
Backpanel header	3.4	2.4	1.9
Coplanar	3.9	2.2	1.7

* See section 4.6 for more information on the Optional short detect pin

** All locations in orthogonal connector have this mating length

NUMBER GS-20-035	TYPE APPLICATION SPECIFICATION		
TITLE AirMax VS [®] Connector System, press-fit products (r/a header, r/a receptacle, vertical header, vertical receptacle & orthogonal assemblies)		PAGE 9 of 33	REVISION J
		AUTHORIZED BY Tan Chen Hong	DATE 18 Aug 09
		STATUS UNRESTRICTED	

4.4 SIGNAL CONNECTOR GUIDING FEATURES:

Tables 5 and 6 show the amount of misalignment in each direction that will be corrected by the guiding features on signal connector housings as they are mated.

Connector type	Nominal misalignment correction in direction perpendicular to daughter card	Nominal misalignment correction in direction parallel to daughter card
5 pair	+/- 1.0 mm	+/- 1.7 mm
4 pair	+/- 0.6 mm	+/- 1.3 mm
3 pair	+/- 1.0 mm	+/- 1.7 mm

Table 5: Connector guidance in each direction (backpanel receptacle & coplanar)

Connector type	Nominal misalignment correction in direction perpendicular to daughter card		Nominal misalignment correction in direction parallel to daughter card
	Wide body	Narrow body	Wide body and Narrow body
5 pair	+/- 2.0 mm	+/- 1.0 mm	+/- 1.7mm
4 pair	+/- 2.0 mm	+/- 1.0 mm	+/- 1.7 mm
3 pair	+/- 2.0 mm	+/- 1.0 mm	+/- 1.7 mm

Table 6: Connector guidance in each direction (backpanel header and orthogonal)

The maximum acceptable angular misalignment of the daughter card relative to the backplane is +/- 2 degrees in either direction in systems that do not use any short detect pins. **If short detect pins are used please refer to section 4.6 for recommendations.**

When an AirMax VS[®] connector is placed adjacent to a non-AirMax VS[®] connector (such as a Millipacs[™] signal connector), care must be taken to make sure there won't be a problem associated with AirMax VS[®] header housings stubbing with adjacent vertical headers on the backplane during mating. The AirMax VS[®] header with end walls will reduce this risk because an outside chamfer is included on the housing. However, AirMax VS[®] headers without end walls do not have chamfers on the outside edges.

NUMBER GS-20-035	TYPE APPLICATION SPECIFICATION		
TITLE AirMax VS [®] Connector System, press-fit products (r/a header, r/a receptacle, vertical header, vertical receptacle & orthogonal assemblies)		PAGE 10 of 33	REVISION J
		AUTHORIZED BY Tan Chen Hong	DATE 18 Aug 09
		STATUS UNRESTRICTED	

4.5 SEPARATE GUIDE MODULES:

It is strongly recommended that separate guide modules be used to maximize the system's mechanical robustness. One guide module should be placed at each end of a group of signal modules. If the amount of bow in a daughter card exceeds the amount of signal connector guidance, then an additional guide module should be placed near the center of a group of signal modules. Please refer to GS-20-045 for additional information on Hard Metric Guide Connectors.

4.6 OPTIONAL SHORT DETECT PIN: (Not available in Orthogonal Connectors)

A standard short detect pin position is offered as a separate dash number on each standard Right Angle header and Vertical header connector drawing. In order to assure proper pin engagement sequencing in various angular mating conditions, the following application constraints are required:

When multiple modules are used, multiple short-detect modules are required (**R/A headers shown in figures**):

3 or more adjacent or non-adjacent modules:

Each end module must have a short detect pin.

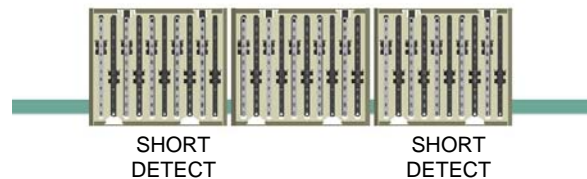

2 adjacent or non-adjacent modules:

Both modules must have a short detect pin.

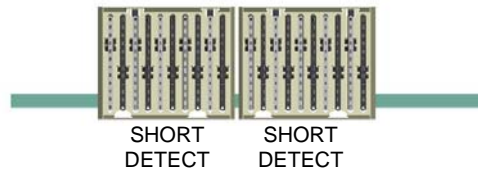

1 single module: A $\pm 1^\circ$ maximum angular mating constraint is required in the plane of the daughter card (see [frame A](#)).

For all applications: A $\pm 1^\circ$ maximum angular mating constraint is required perpendicular to the plane of the daughter card (see [frame B](#)).

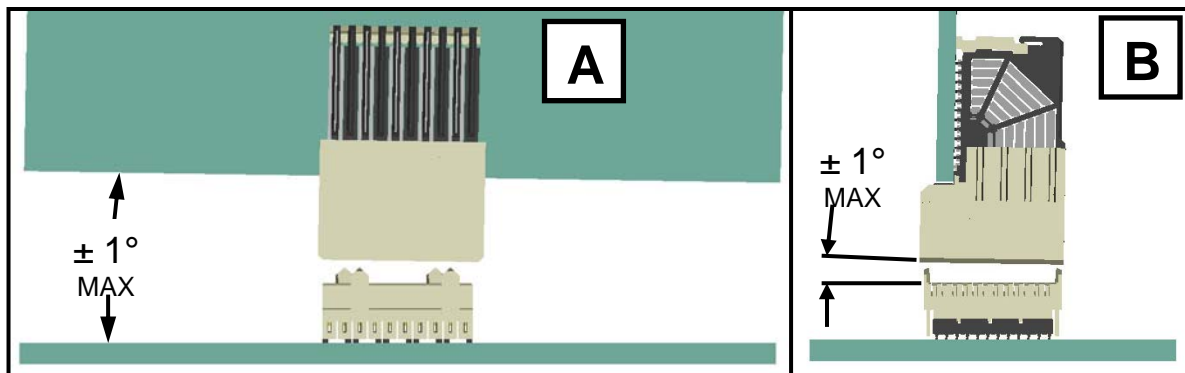

NUMBER GS-20-035	TYPE APPLICATION SPECIFICATION		
TITLE AirMax VS [®] Connector System, press-fit products (r/a header, r/a receptacle, vertical header, vertical receptacle & orthogonal assemblies)		PAGE 11 of 33	REVISION J
		AUTHORIZED BY Tan Chen Hong	DATE 18 Aug 09
STATUS UNRESTRICTED			

5. REQUIREMENTS FOR CUSTOMER PCB LAYOUT

5.1. HEADER END WALL OPTION

The purpose of header end walls is to provide added mechanical protection to the header pin field. The trade-off of this added protection is a slight reduction in signal density per linear card inch (see Table 7).

Positions per assembly	Diff pairs per column	Number of columns	Module width (mm)	Diff Pairs per inch of card edge	Signal lines per inch of card edge*
150	5	10	20	63.5	190.6
			22	57.7	173.2
150	5	10	30	42.3	127.0
			32	39.7	119.0
120	5	8	16	63.5	190.6
			18	56.4	169.4
120	4	10	20	50.8	152.4
			22	46.2	138.6
120	4	10	30	33.9	101.6
			32	31.8	95.2
96	4	8	16	50.8	152.4
			18	45.2	135.4
90	3	10	22	38.1	114.4
			20	34.6	104.0
72	4	6	12	50.8	152.4
			14	43.5	130.6
72	3	8	16	38.1	114.4
			18	33.9	101.6
54	3	6	12	38.1	114.4
			14	32.7	98.0
48**	4	4	16.6	24.2	72.6

**Table 7: signal density for each AirMax VS[®] connector configuration
(All values have been rounded to the nearest 0.1 increment)**

* There is no ground bussing within the connector system.

** Orthogonal connector

In general, the connector-to-connector centerline spacing will depend on the chosen header configuration with respect to end wall design. For example, if all headers on a given daughter card are 54-position with end walls, then the connector pitch will be 14.0mm for that card. However if all headers are 54-position without end walls, the connector pitch will be 12.0mm. If there is a mixture of 54-position headers with end walls and without end walls, then the centerline distance between any two adjacent dissimilar headers will be 13.0mm. This type of PCB layout information is included on all AirMax VS[®] customer drawings.

NUMBER GS-20-035	TYPE APPLICATION SPECIFICATION		
TITLE AirMax VS [®] Connector System, press-fit products (r/a header, r/a receptacle, vertical header, vertical receptacle & orthogonal assemblies)		PAGE 12 of 33	REVISION J
		AUTHORIZED BY Tan Chen Hong	DATE 18 Aug 09
		STATUS UNRESTRICTED	

5.2. DIFFERENTIAL PAIR vs. SINGLE-ENDED LAYOUTS

The same AirMax VS[®] connector may be used for differential pair or single-ended applications. Each FCI customer drawing shows recommended PCB layouts for differential-only and single-ended-only applications. It is important to note that differential and single-ended pin assignments may be mixed within the same column. **It is recommended that the customer review any mixed layout with FCI to optimize high-speed performance.**

5.3. PIN ASSIGNMENTS FOR ORTHOGONAL HEADER FOOTPRINTS

AirMax VS[®] orthogonal headers have offset press-fit tails so each differential signal pair on one side of the midplane will share the same PCB via's as a differential signal pair on the opposite side of the midplane. Therefore, the midplane does not require any high speed routing, which allows for layer count and cost minimization of the midplane. Unlike the differential signal pairs, the ground pins are not directly connected through the same via from front to back, but would be connected through ground planes within the midplane. For example, in Table 8, signal (S) pin J1 on the front connector connects directly to signal pin B4 on the rear connector; while ground (G) pin L1 on the front connector is not directly connected to ground pin C4 on the rear connector. Table 8 lists which differential signal pins are directly connected through PCB via's.

Front		Rear		Front		Rear		Front		Rear		Front		Rear		Pin Type
A	1	B	1	A	2	E	1	A	3	H	1	A	4	K	1	S
B	1	A	1	B	2	D	1	B	3	G	1	B	4	J	1	S
C	1	None		C	2	None		C	3	None		C	4	None		G
None		C	1	None		F	1	None		I	1	None		L	1	G
D	1	B	2	D	2	E	2	D	3	H	2	D	4	K	2	S
E	1	A	2	E	2	D	2	E	3	G	2	E	4	J	2	S
F	1	None		F	2	None		F	3	None		F	4	None		G
None		C	2	None		F	2	None		I	2	None		L	2	G
G	1	B	3	G	2	E	3	G	3	H	3	G	4	K	3	S
H	1	A	3	H	2	D	3	H	3	G	3	H	4	J	3	S
I	1	None		I	2	None		I	3	None		I	4	None		G
None		C	3	None		F	3	None		I	3	None		L	3	G
J	1	B	4	J	2	E	4	J	3	H	4	J	4	K	4	S
K	1	A	4	K	2	D	4	K	3	G	4	K	4	J	4	S
L	1	None		L	2	None		L	3	None		L	4	None		G
None		C	4	None		F	4	None		I	4	None		L	4	G

Table 8: Midplane connections for orthogonal headers

NUMBER GS-20-035	TYPE APPLICATION SPECIFICATION		
TITLE AirMax VS® Connector System, press-fit products (r/a header, r/a receptacle, vertical header, vertical receptacle & orthogonal assemblies)		PAGE 13 of 33	REVISION J
		AUTHORIZED BY Tan Chen Hong	DATE 18 Aug 09
		STATUS UNRESTRICTED	

5.4 PCB TRACE ROUTING

To minimize trace loss in high-speed systems, board designers typically prefer to use trace widths no smaller than 0.20mm (0.008"). The desired impedance between adjacent traces will define the spacing between those traces. The board designer will ultimately determine these parameters for a given system.

5.4.1 2mm pitch between adjacent columns

The 2mm pitch between columns allows one differential pair or two single-ended lines to be routed per PCB layer. This assumes 0.20mm (0.008") wide traces and a 0.20mm (0.008") wide space between a pair of traces. Refer to Figure 9 for a trace routing example.

		Layout	
		mil	um
Column pitch	CP	79.0	2000
Trace	W	8.0	203
Space	S	8.0	203
Pad	P	36.0	914
Antipad	Wa	49.0	1245
Total Routing Width	TRW	24.0	610
Annular Ring	Wr	8.2	207
Clearance Drill - Trace	Cd-t	15.7	399
Clearance Pad-Trace	Cp-t	9.5	241
Clearance Antipad-Trace	Ca-t	3.0	76

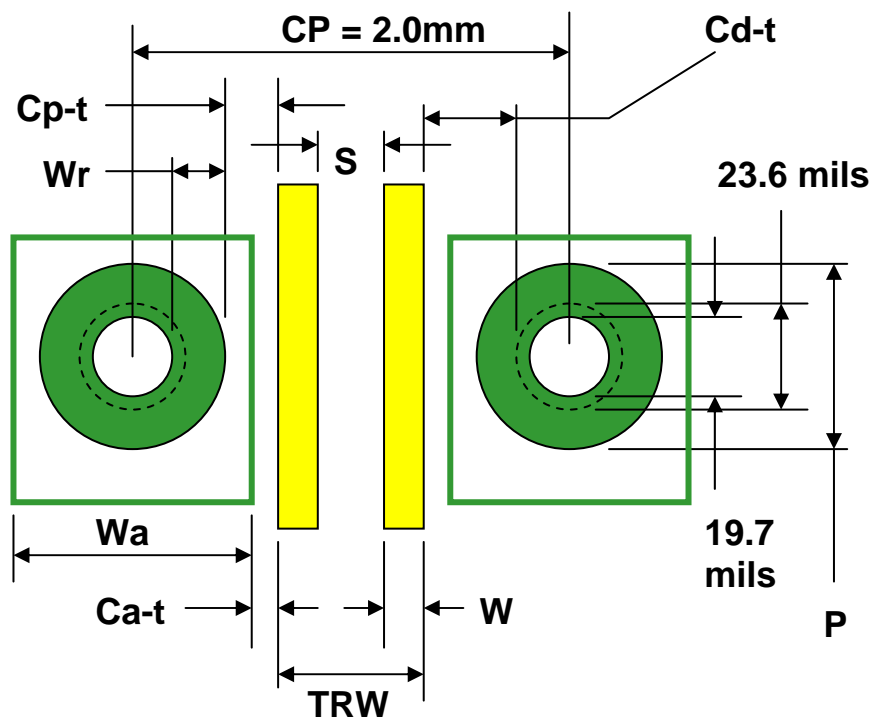



Figure 9: PCB trace routing example, 2mm pitch between columns

NUMBER	GS-20-035	TYPE	APPLICATION SPECIFICATION		
TITLE	AirMax VS® Connector System, press-fit products (r/a header, r/a receptacle, vertical header, vertical receptacle & orthogonal assemblies)			PAGE	14 of 33
				REVISION	J
			AUTHORIZED BY	DATE	Tan Chen Hong 18 Aug 09
			STATUS	UNRESTRICTED	

5.4.2 3mm pitch between adjacent columns

The 3mm pitch allows two differential pairs or four single-ended lines to be routed per PCB layer. For differential applications this assumes 0.20mm (0.008") wide traces, a 0.20mm (0.008") wide space between a pair of traces, and a pair-to-pair spacing of 0.45mm (0.018"). Larger traces and/or spaces could be used for a single-ended application. Refer to Figure 10, which shows a trace routing example for a differential application.

		Layout	
		mil	um
Column pitch	CP	118.0	2997
Trace	W	8.0	203
Space	S	8.0	203
Pair-Pair spacing	Spp	18.0	457
Pad	P	36.0	914
Antipad	Wa	48.0	1219
Total Routing Width	TRW	66.0	1676
Annular Ring	Wr	8.2	207
Clearance Drill - Trace	Cd-t	14.2	361
Clearance Pad-Trace	Cp-t	8.0	203
Clearance Antipad-Trace	Ca-t	2.0	51

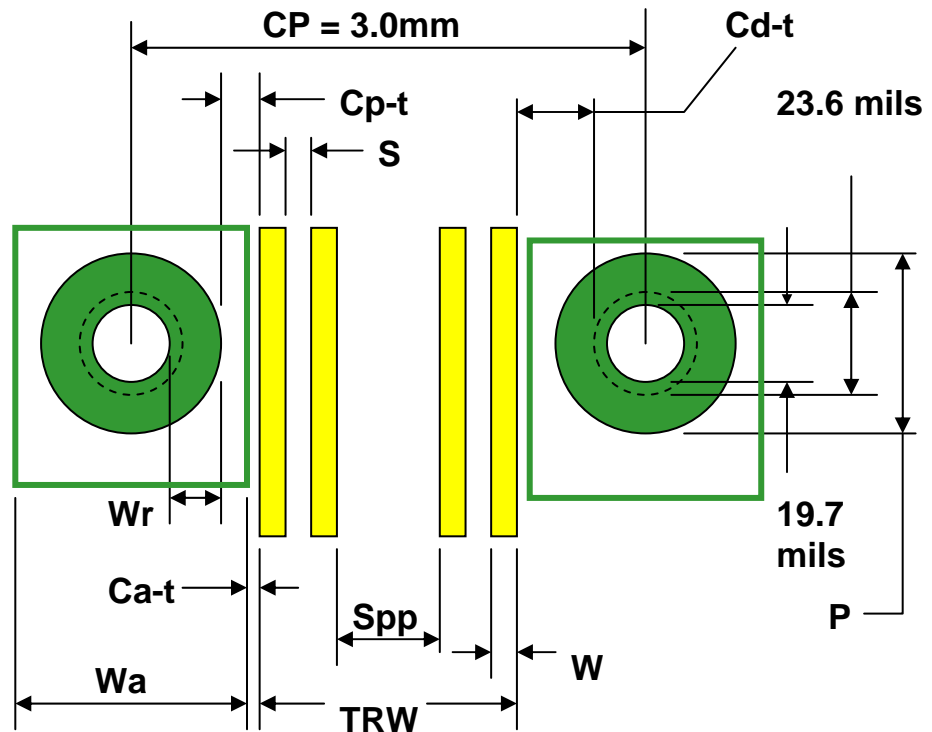



Figure 10: PCB trace routing example, 2mm pitch between columns

NUMBER GS-20-035	TYPE APPLICATION SPECIFICATION		
TITLE AirMax VS® Connector System, press-fit products (r/a header, r/a receptacle, vertical header, vertical receptacle & orthogonal assemblies)		PAGE 15 of 33	REVISION J
		AUTHORIZED BY Tan Chen Hong	DATE 18 Aug 09
		STATUS UNRESTRICTED	

5.4.3 Orthogonal, 4.2mm pitch between adjacent columns

The 4.2mm pitch allows for up to three differential pairs or six single-ended lines to be routed per right angle receptacle PCB layer, and when header is used as a backpanel connector, up to two differential pairs or four single-ended lines can be routed per header PCB layer. For differential applications this assumes 0.18mm (0.007") wide traces for the RAR, 0.165 mm (0.0065") wide traces for the header, and a pair-to-pair spacing of 0.457mm (0.018") for both. Larger traces and/or spaces could be used for a single-ended application. Refer to Figures 11 and 12, which show trace routing examples for a differential application.

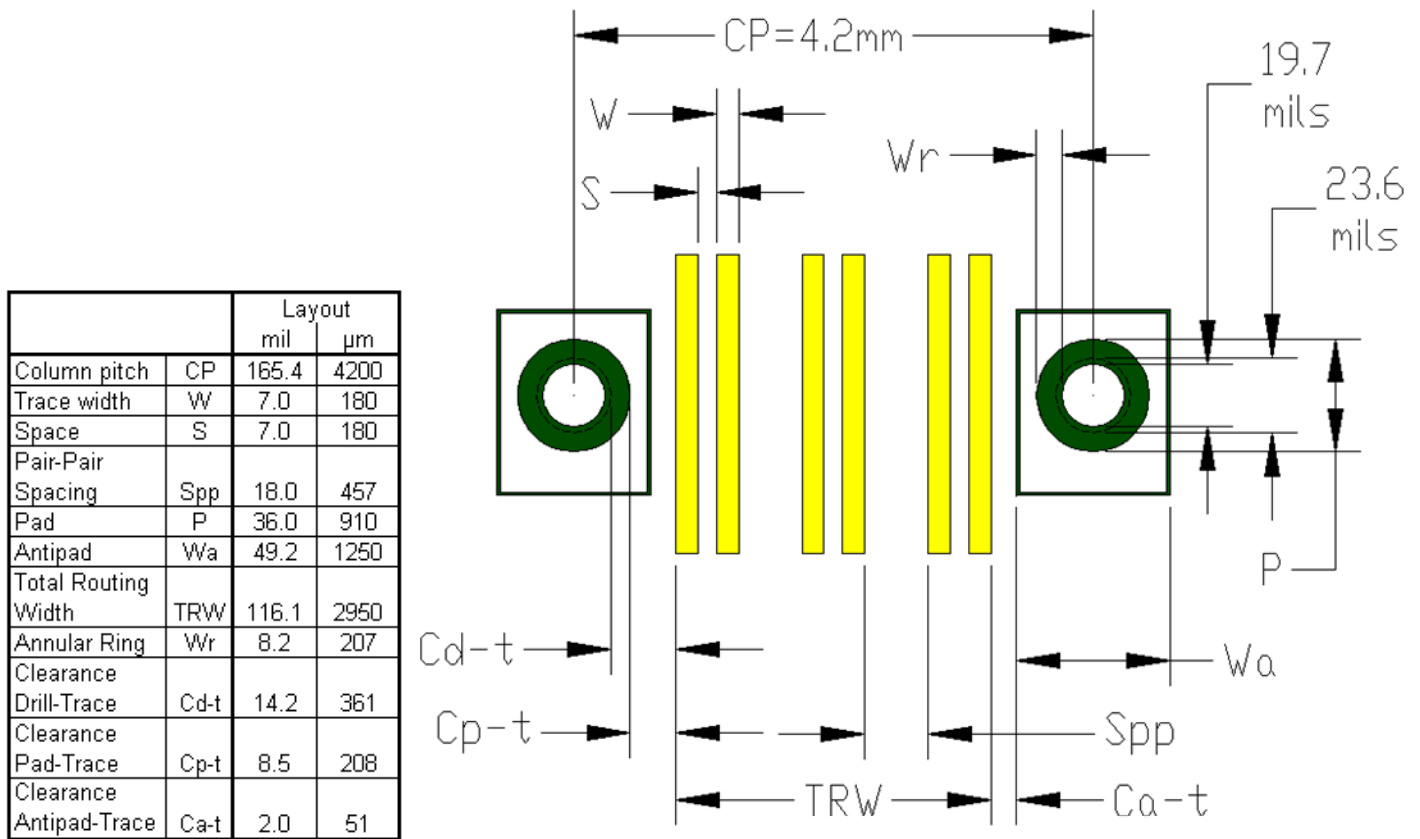

Figure 11: Orthogonal RAR PCB trace routing example, 4.2mm pitch between columns

NUMBER GS-20-035	TYPE APPLICATION SPECIFICATION	FCI	
TITLE AirMax VS® Connector System, press-fit products (r/a header, r/a receptacle, vertical header, vertical receptacle & orthogonal assemblies)		PAGE 16 of 33	REVISION J
		AUTHORIZED BY Tan Chen Hong	DATE 18 Aug 09
		STATUS UNRESTRICTED	

		Layout	
		mil	µm
Column pitch	CP	165.4	4200
Tail Off-set	TO	27.6	700
Trace width	W	6.5	165
Space	S	6.5	165
Pair-Pair Spacing	Spp	18.0	457
Pad	P	36.0	910
Antipad	Wa	49.2	1250
Total Routing Width	TRW	61.0	1550
Annular Ring	Wr	8.2	207
Clearance Drill-Trace	Cd-t	14.2	361
Clearance Pad-Trace	Cp-t	8.0	203
Clearance Antipad-Trace	Ca-t	2.0	51

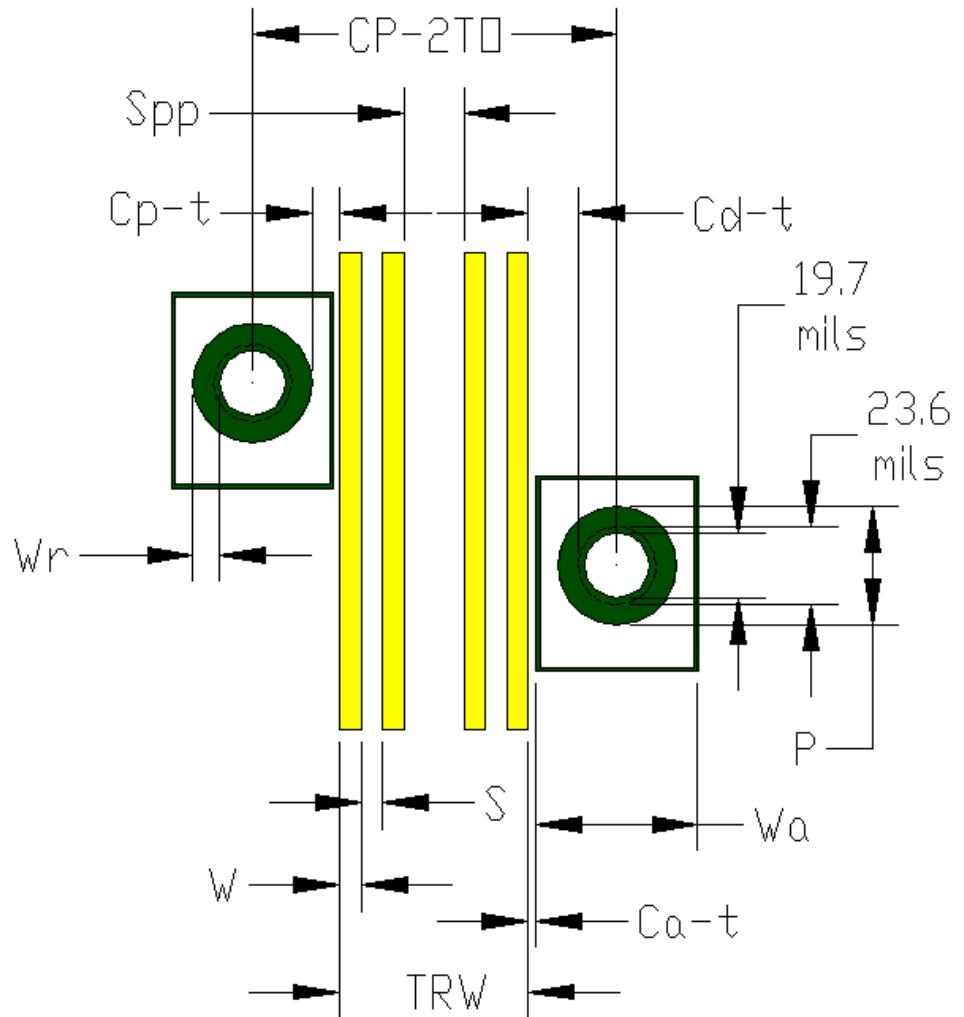



Figure 12: Orthogonal Header PCB trace routing example, 4.2mm pitch between columns

5.5 PRINTED CIRCUIT BOARD THICKNESS

The minimum nominal PCB thickness recommendation for daughter cards and backplanes is 1.60mm. There is no maximum thickness requirement.

NUMBER GS-20-035	TYPE APPLICATION SPECIFICATION		
TITLE AirMax VS [®] Connector System, press-fit products (r/a header, r/a receptacle, vertical header, vertical receptacle & orthogonal assemblies)		PAGE 17 of 33	REVISION J
		AUTHORIZED BY Tan Chen Hong	DATE 18 Aug 09
		STATUS UNRESTRICTED	

5.6 BACKDRILLING GUIDELINES:

Backdrilling is a method used by system designers that reduces the length of a conductive via which will improve high speed signal integrity performance. When backdrilling is performed it is important to avoid damaging the portion of the via that makes contact with any press-fit tails. See below for recommendations on proper backdrilling.

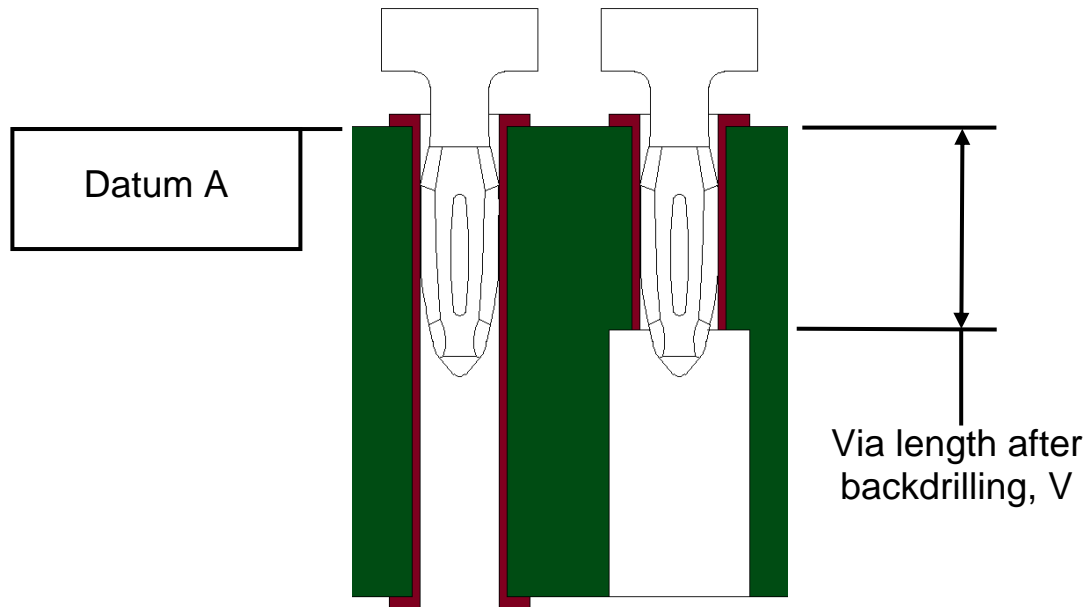

After a backdrilling operation, the remaining via barrel (dim V) must be at least 1.3mm minimum to ensure a reliable connection between the AirMax VS[®] press-fit tails and the PCB. Assuming PCB vendor has a backdrilling depth tolerance of +/- 0.3mm relative to datum A, the nominal via length V will be 1.6mm (min V = 1.3mm; max V = 1.9mm).

5.7 PCB SCREEN PRINTING RECOMMENDATIONS:

For vertical headers, it is recommended to print polarization recognition features on the PCB. This will help ensure the connector is properly oriented when placed onto the board prior to press-fit application. These features include a triangle corresponding to the connector pin A1 position and a printed line on the PCB to match a cut-out in the connector base. See Figure 14 and section 7.2 for additional explanation.

5.8 KEEP-OUT ZONES FOR APPLICATION AND REMOVAL TOOLING:

There are no keep-out zones necessary for application tooling because these tools fit within the outside envelope of the header and receptacle assemblies.

There may be a need for keep-out zones for connector removal tooling. Refer to the FCI Manuals listed in section 9 for information on removal tools and procedures. In general, the need for keep-outs will depend on the specific PCB layout. To be more specific, factors such as pitch definition between adjacent daughter cards, selection of headers with end walls or without, and location and type of any nearby connectors all affect the requirements. It is possible to design a system so that no extra keep-out zones are needed.

NUMBER GS-20-035	TYPE APPLICATION SPECIFICATION		
TITLE AirMax VS [®] Connector System, press-fit products (r/a header, r/a receptacle, vertical header, vertical receptacle & orthogonal assemblies)		PAGE 18 of 33	REVISION J
		AUTHORIZED BY Tan Chen Hong	DATE 18 Aug 09
		STATUS UNRESTRICTED	

6 APPLICATION TOOLING

6.1 RIGHT ANGLE HEADER (150 position shown)

The application tools recommended for AirMax VS[®] right angle headers are shown in Table 9. **A special bottom support tool will be necessary only if the connector tails are longer than the thickness of the daughter card (the tail length specification is 1.60mm +/- 0.15mm).** This tool could be a PCB with oversized holes or a custom tool designed by the user.

Header type	Module width, mm	Insertion tool part no.
150 position (5 pair)	20 or 22	430276
150 position (5 pair)	30 or 32	430301
120 position (5 pair)	16 or 18	430326
120 position (5 pair)	24 or 26	10071198
120 position (4 pair)	20 or 22	430393
120 position (4 pair)	30 or 32	430306
96 position (4 pair)	16 or 18	430394
90 position (3 pair)	20 or 22	430351
72 position (4 pair)	12 or 14	434395
72 position (3 pair)	16 or 18	430343
54 position (3 pair)	12 or 14	430325

Table 9: part numbers for header application tools

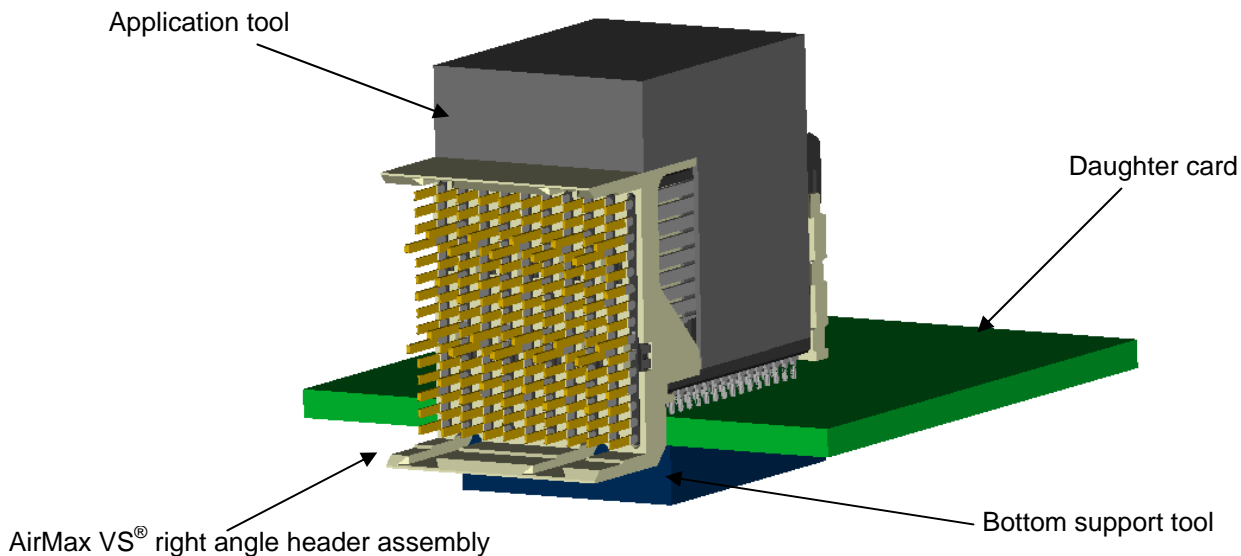

NUMBER GS-20-035	TYPE APPLICATION SPECIFICATION		
TITLE AirMax VS® Connector System, press-fit products (r/a header, r/a receptacle, vertical header, vertical receptacle & orthogonal assemblies)		PAGE 19 of 33	REVISION J
		AUTHORIZED BY Tan Chen Hong	DATE 18 Aug 09
		STATUS UNRESTRICTED	

6.2 VERTICAL HEADER (150 position shown)

The AirMax VS® vertical header is supplied with standard protection cover, which also acts as a flat-rock application tool. The nominal press-in height is for all versions is 16.5mm. The latches on the protection cover can be removed to make a reusable application tool (see below). Part numbers for protection covers are listed in Table10.

Header type	Module width, mm	Protection cover part no.
150 position (5 pair)	20 or 22	10055141-103
150 position (5 pair)	30 or 32	10056449-103
96 position (5 pair)	16 or 18	10055141-102
120 position (4 pair)	20 or 22	10055306-103
120 position (4 pair)	30 or 32	10056450-103
96 position (4 pair)	24 or 26	10056450-102
96 position (3 pair)	20 or 22	10055602-103
54 position (3 pair)	12 or 14	10055602-101
48 position (Orthogonal)	16.6	10073722-001

Table 10: part numbers for vertical header protection covers

A special bottom support tool will be necessary only if the connector tails are longer than the thickness of the daughter card (the tail length specification is 1.60mm +/- 0.15mm). This tool could be a PCB with oversized holes or a custom tool designed by the user.

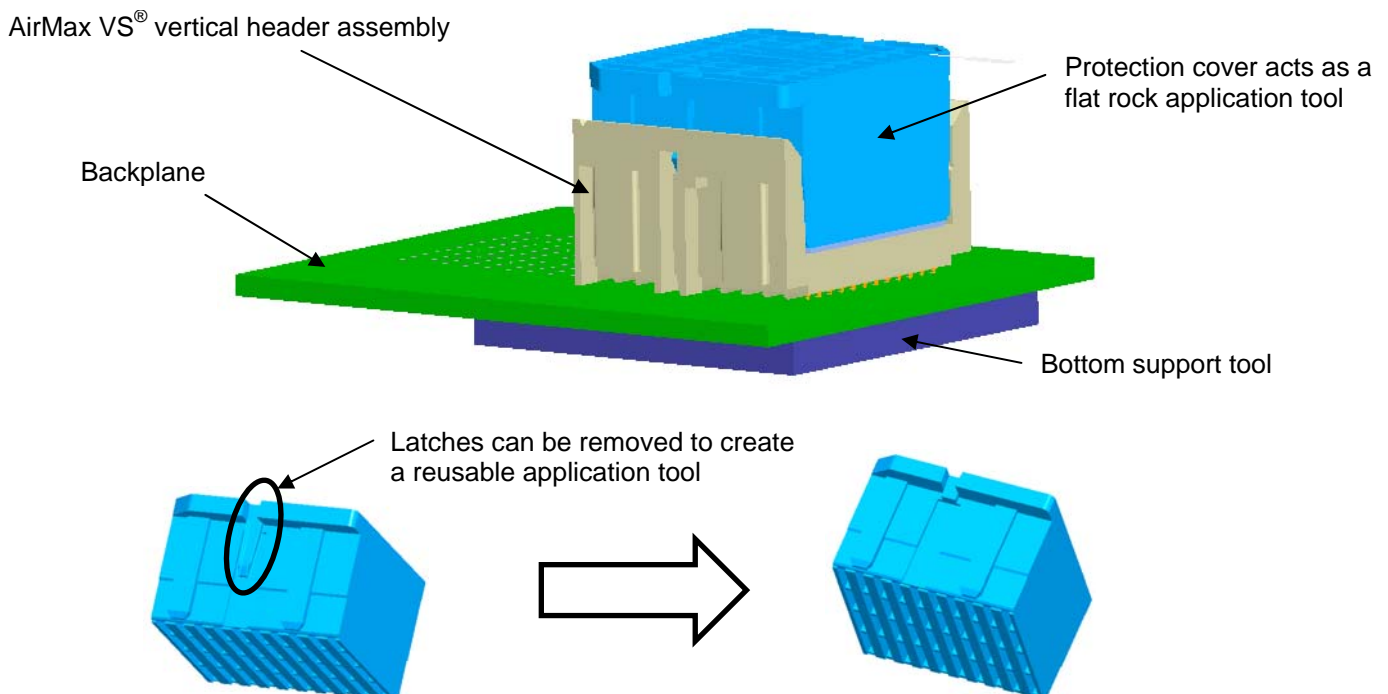

NUMBER GS-20-035	TYPE APPLICATION SPECIFICATION		
TITLE AirMax VS® Connector System, press-fit products (r/a header, r/a receptacle, vertical header, vertical receptacle & orthogonal assemblies)		PAGE 20 of 33	REVISION J
		AUTHORIZED BY Tan Chen Hong	DATE 18 Aug 09
		STATUS UNRESTRICTED	

6.3 RIGHT ANGLE RECEPTACLE (150 position shown)

The application tools recommended for AirMax VS® receptacles are shown in Table 11. **A special bottom support tool will be necessary only if the connector tails are longer than the thickness of the daughter card (the tail length specification is 1.60mm +/- 0.15mm).** This tool could be a PCB with oversized holes or a custom tool designed by the user.

Receptacle type	Module width, mm	Insertion tool part no.
150 position (5 pair)	20	10041881
150 position (5 pair)	30	10059234
120 position (5 pair)	16	10050658
120 position (4 pair)	20	10058126
120 position (4 pair)	30	10058128
96 position (4 pair)	16	10064163
96 position (4 pair)	24	10078270
90 position (3 pair)	20	10066103
54 position (3 pair)	12	10058127
48 position (Orthogonal)	16.6	10075134

Table 11: part numbers for receptacle application tools

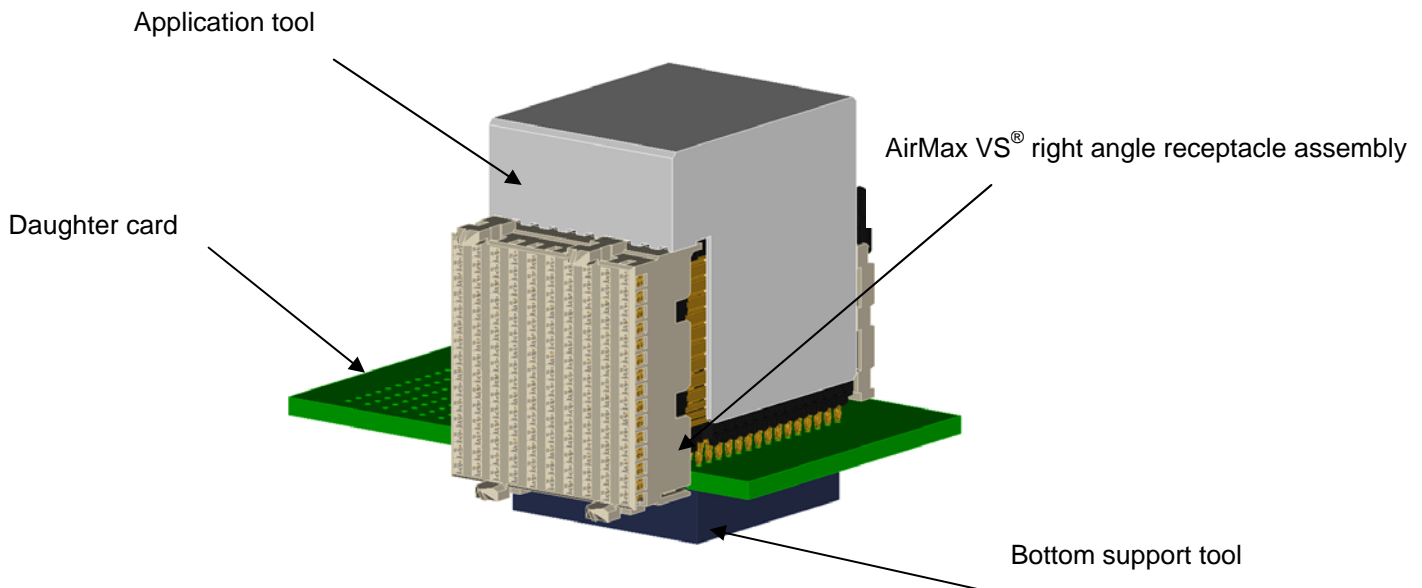

NUMBER GS-20-035	TYPE APPLICATION SPECIFICATION		
TITLE AirMax VS [®] Connector System, press-fit products (r/a header, r/a receptacle, vertical header, vertical receptacle & orthogonal assemblies)		PAGE 21 of 33	REVISION J
		AUTHORIZED BY Tan Chen Hong	DATE 18 Aug 09
		STATUS UNRESTRICTED	

6.4 VERTICAL RECEPTACLE (150 position shown)

The application tools recommended for AirMax VS[®] vertical receptacles are shown in Table 12. **A special bottom support tool will be necessary only if the connector tails are longer than the thickness of the daughter card (the tail length specification is 1.60mm +/- 0.15mm).** This tool could be a PCB with oversized holes or a custom tool designed by the user.

Receptacle type	Module width, mm	Insertion tool part no.
150 position (5 pair)	20	430277
150 position (5 pair)	30	430302
120 position (5 pair)	16	430327
120 position (5 pair)	24	10071199
120 position (4 pair)	20	430396
120 position (4 pair)	30	430309
96 position (4 pair)	16	430397
90 position (3 pair)	20	430352
72 position (4 pair)	12	430398
72 position (3 pair)	16	430344
54 position (3 pair)	12	430324

Table 12: part numbers for receptacle application tools

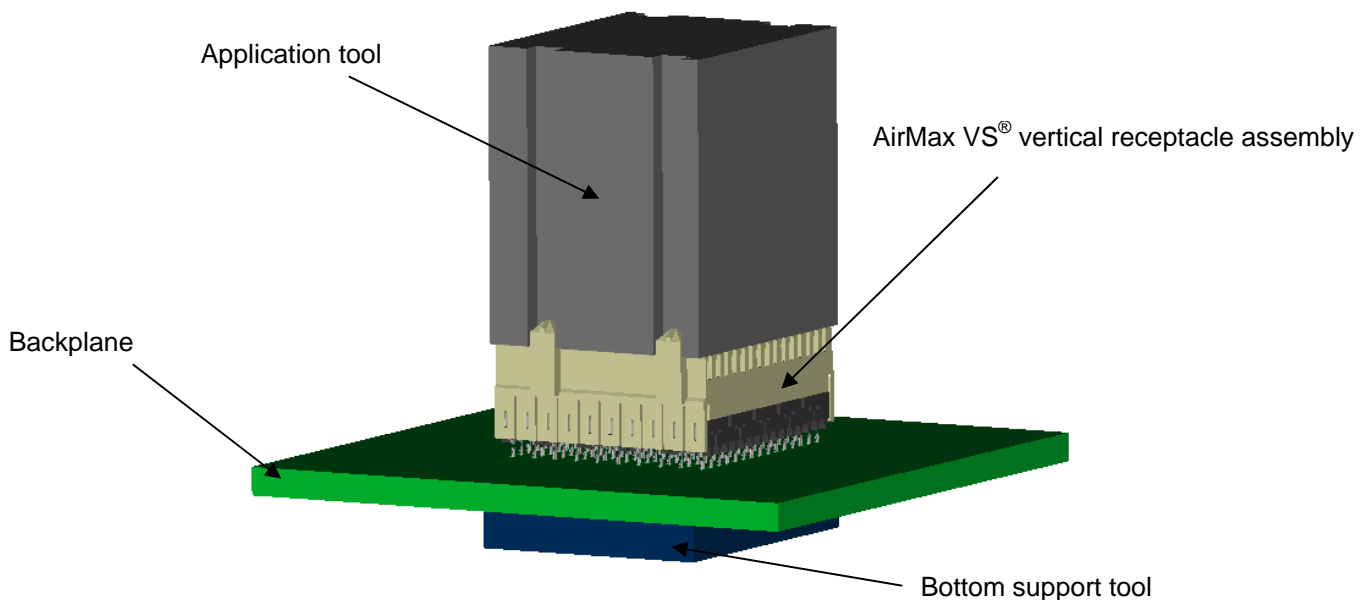

NUMBER GS-20-035	TYPE APPLICATION SPECIFICATION		
TITLE AirMax VS [®] Connector System, press-fit products (r/a header, r/a receptacle, vertical header, vertical receptacle & orthogonal assemblies)		PAGE 22 of 33	REVISION J
		AUTHORIZED BY Tan Chen Hong	DATE 18 Aug 09
		STATUS UNRESTRICTED	

6.5 CUSTOM TOOLING

Custom application tooling can be provided by FCI for pressing several connectors simultaneously.

6.6 INSERTION PRESSES

6.6.1 Considerations when specifying a press

The specified application tooling can work in a variety of presses. Several important items to consider when selecting an insertion press include:

- The press must have sufficient force capabilities to insert the specific receptacle configuration.
- The press ram should be sufficiently long to cover the Press Block tooling. This will prevent tooling flex.
- The press table should be large enough to properly accommodate the PCB size.

Typical press types include:

- Manual arbor press
- Pneumatic press
- Hydraulic press
- Servo driven electronic press (IMPRESS)

The preferred press type is the servo driven electronic press. This press gives the best control during the insertion process and offers the most flexibility. FCI offers arbor, pneumatic and electronic presses. For more information, contact your local Customer Service Representative.

Typical frame types include:

- "C" frame: a frame design where the press ram and press table are connected by a structural member at the rear of the press table
- "H" frame: a frame design where the press ram and press table are connected by a structural members at both sides of the press table

NUMBER	GS-20-035	TYPE	APPLICATION SPECIFICATION			
TITLE	AirMax VS [®] Connector System, press-fit products (r/a header, r/a receptacle, vertical header, vertical receptacle & orthogonal assemblies)		PAGE	23 of 33	REVISION	J
			AUTHORIZED BY	Tan Chen Hong	DATE	18 Aug 09
			STATUS	UNRESTRICTED		

6.6.2 FCI Insertion press specifications

FCI provides a range of state-of-the-art press-fit insertion machines. The IMPRESS family includes the following types:

- **IMPRESS 2000**: modular based fully automated pick-and-place insertion machine
- **IMPRESS 1000**: semi-automatic step-and-repeat press with motor driven XY-table
- **IMPRESS 500E**: hand operated servo driven C-frame press
- **Baby IMPRESS**: flat bed servo motor driven bench press
- **IMPRESS 500M+**: hand operated C-frame bench press

Refer to the following table for press specifications for the above mentioned press types:

SPECIFICATION	IMPRESS MODEL NO.				
	2000 XL	1000 XXL	500E	Baby IMPRESS	500M+
Catalog No.	PAH13302	PAH156	PAY284A2	PAY326	PAY479
Press force	40 kN	80 kN	80 kN	20 - 50 kN	15 kN
Max board size	950 x 635 mm	1200 x 625 mm	720 x 580 mm	600 mm between posts of the H-bridge	270 mm throat depth
Max tool size	160 mm	255 mm	255 mm	255 mm	150 mm
Press cycles per hour	900	700 - 900	600	500	300
Tool exchange	Automatic	Manual or Automatic (option)	Manual	Manual	Manual
Board stuffing	Automatic pick-and-place	Manual	Manual	Manual	Manual
Board positioning	Automatic	Automatic	Manual (LMT-system optional)	Manual	Manual
Board support	Rising post	Rising post	Rising post	Flat bed	Fixed anvil or Flat bed
Force controlled press stroke	Provided	Provided	Provided	Provided	Not provided

NUMBER	GS-20-035	TYPE	APPLICATION SPECIFICATION		
TITLE	AirMax VS [®] Connector System, press-fit products (r/a header, r/a receptacle, vertical header, vertical receptacle & orthogonal assemblies)			PAGE	24 of 33
				AUTHORIZED BY	Tan Chen Hong
				DATE	18 Aug 09
				STATUS	UNRESTRICTED

7 APPLICATION PROCEDURE

7.1 RIGHT ANGLE HEADER & RECEPTACLE (150 position shown)

The application procedure for the right angle header and receptacle is as follows:

- Place connector assembly in the desired location on the daughter card taking care to assure that all press-fit tails line up with the proper holes.

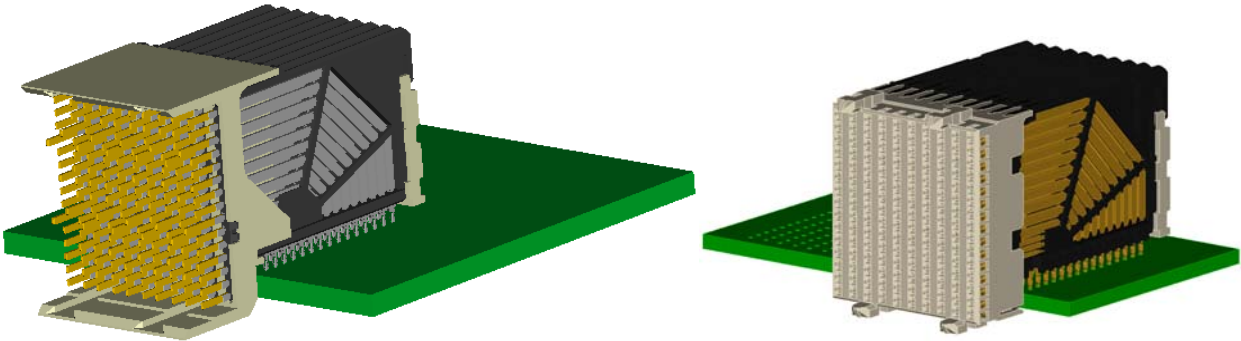

- Place the application tool in the proper location with respect to the connector assembly as shown below.

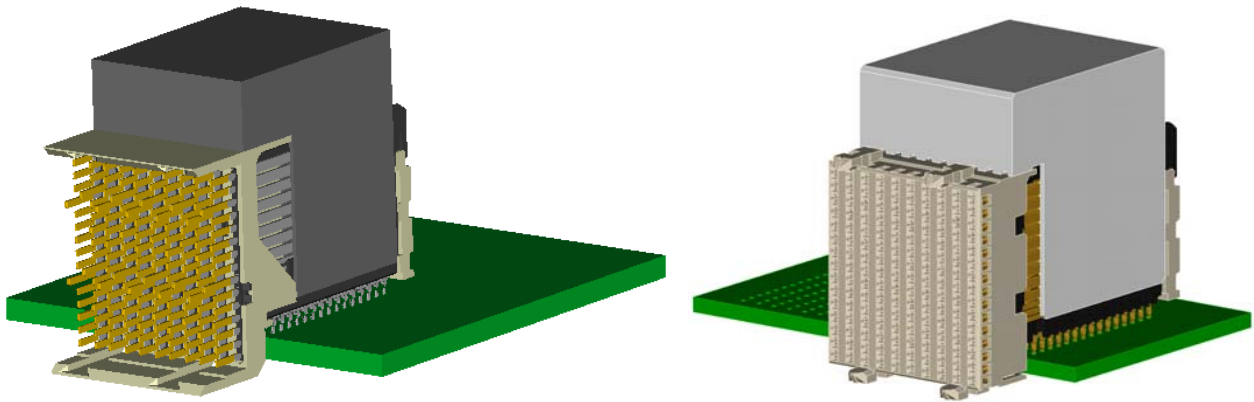

- **To ensure proper insertion, connectors must be centered beneath the press ram.** Offset loading may result in improper seating of the header and mating problems.

NUMBER	GS-20-035	TYPE	APPLICATION SPECIFICATION		
TITLE	AirMax VS [®] Connector System, press-fit products (r/a header, r/a receptacle, vertical header, vertical receptacle & orthogonal assemblies)			PAGE	25 of 33
				REVISION	J
			AUTHORIZED BY	DATE	18 Aug 09
			Tan Chen Hong		
			STATUS	UNRESTRICTED	

7.2 VERTICAL HEADER & RECEPTACLE (150 position shown)

The application procedure for a header or a receptacle is as follows:

- Place connector assembly in the desired location on the backplane taking care to assure that all press-fit tails line up with the proper holes. For the vertical header, it is important to mount the connector in the correct orientation. Several features are designed to assist proper mounting. Triangles on the housing indicate the pin A1 position, the product marking is always found on the A1 side, and a cut-out exists in the housing base on the side that opposes the pin A1 side. This same cut-out polarizes the product in packaging tubes. It is recommended to screen print the triangle mark and a line at the opposite side (see Figure 13).

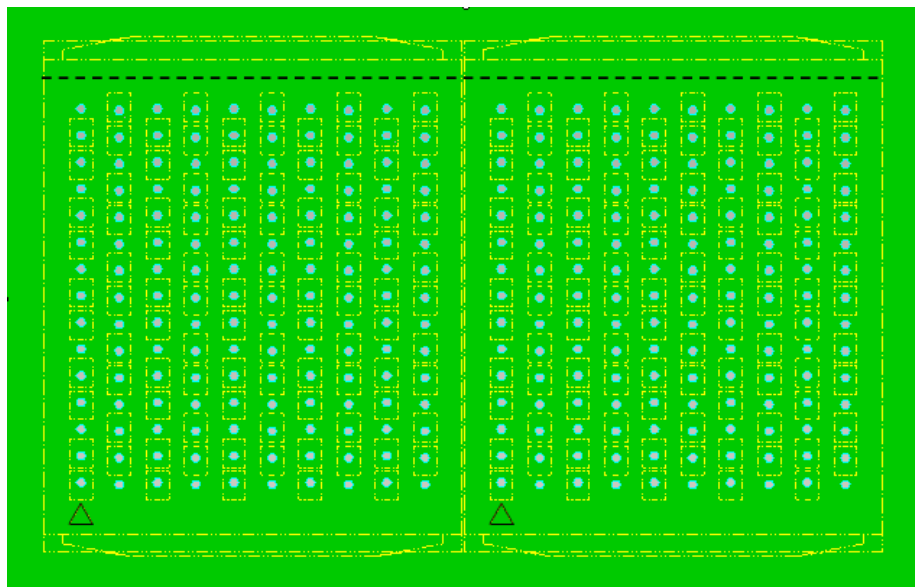
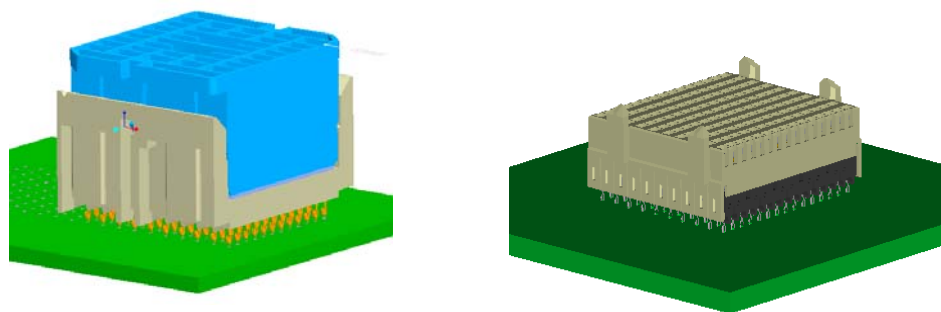



Figure 13: PCB footprint with screen printed triangle marks at each pin A1 and connector cut-out line



- Each vertical header is supplied with a protection cover. Separate top insertion tooling is not required.

NUMBER GS-20-035	TYPE APPLICATION SPECIFICATION		
TITLE AirMax VS [®] Connector System, press-fit products (r/a header, r/a receptacle, vertical header, vertical receptacle & orthogonal assemblies)		PAGE 26 of 33	REVISION J
		AUTHORIZED BY Tan Chen Hong	DATE 18 Aug 09
		STATUS UNRESTRICTED	

- Place a Press Bar (vertical receptacle only) and a PCB Support in the proper location with respect to the receptacle and PCB as shown below.

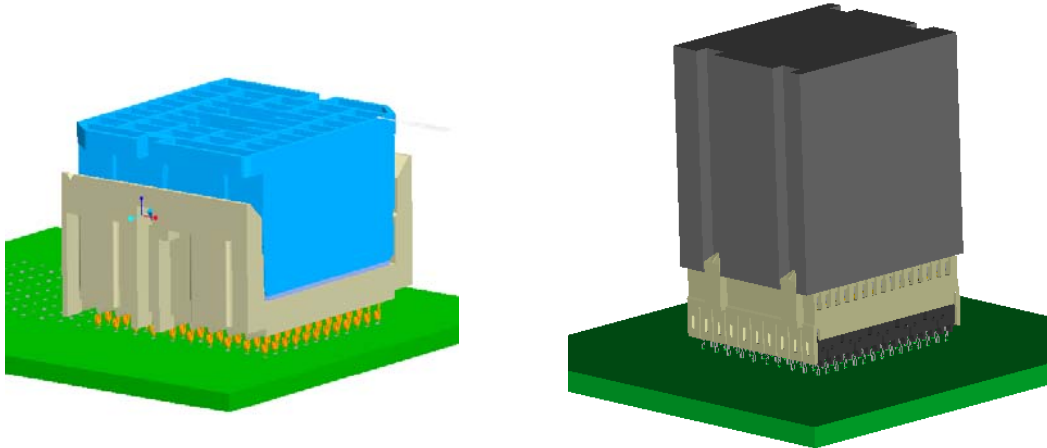

- **To ensure proper insertion, connectors must be centered beneath the press ram.** Offset loading may result in improper seating of the header and mating problems.

- The vertical header protection cover may be removed by hand after press-fit application is completed. However it is recommended that the cover be retained within the vertical header assembly for added protection during additional assembly steps. The protection cover must be removed prior to mating a receptacle connector to the vertical header.

- In the event that user choose to retain protection cover in back-panel system prior to daughter card-mating, a pliers-catch release is incorporated on the top surface of protection cover for easy reach or removal.

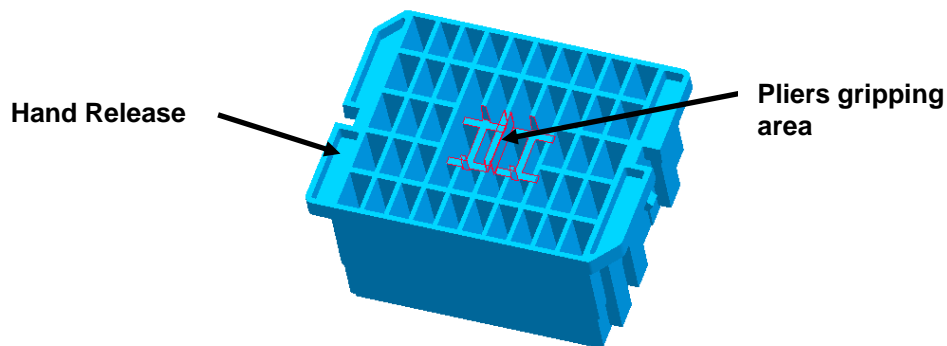

NUMBER GS-20-035	TYPE APPLICATION SPECIFICATION		
TITLE AirMax VS [®] Connector System, press-fit products (r/a header, r/a receptacle, vertical header, vertical receptacle & orthogonal assemblies)		PAGE 27 of 33	REVISION J
		AUTHORIZED BY Tan Chen Hong	DATE 18 Aug 09
		STATUS UNRESTRICTED	

RECOMMENDED INSERTION FORCES

The recommended maximum insertion force for each right angle header, vertical header, and right angle receptacle press-fit pin is 40 N (8.99 lbf).

The recommended maximum insertion force for each vertical receptacle press-fit pin is 25 N (5.62 lbf).

These maximum force recommendations have been determined to yield acceptable insertion results for PCB holes within FCI's recommended guidelines. **While it is acceptable to use a lower insertion force per press-fit pin, steps should be taken to guarantee that the connector is seated properly (see Section 8).** Force settings may vary with different types of PTH finishes. Customers should develop parameters that best suit individual application requirements.

EXAMPLE: For one AirMax VS[®] vertical receptacle module shown below, there are 150 press-fit tails being inserted into the PC board. Therefore, the maximum recommended press setting would be 3750 N (150 press-fit tails x 25 N) or 843 lbf.

- Actuate the insertion press

Actuation of the insertion press should be slow and controlled, not fast like a punch press. To prevent improperly pressed connectors (i.e bent pins), it recommended that press speed should not be more than 75mm/min (0.05 inch/sec). Inserting to a specified force will yield more consistent results than inserting to a set distance.

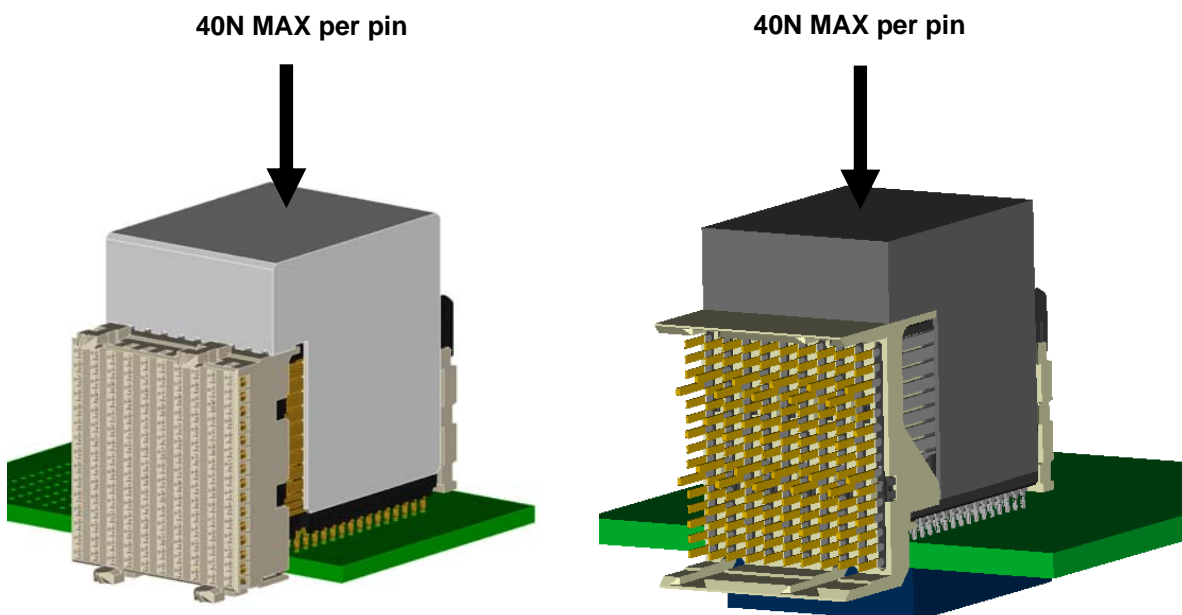

NUMBER	GS-20-035	TYPE	APPLICATION SPECIFICATION			
TITLE	AirMax VS® Connector System, press-fit products (r/a header, r/a receptacle, vertical header, vertical receptacle & orthogonal assemblies)				PAGE	28 of 33
					REVISION	J
					AUTHORIZED BY	Tan Chen Hong
STATUS					UNRESTRICTED	

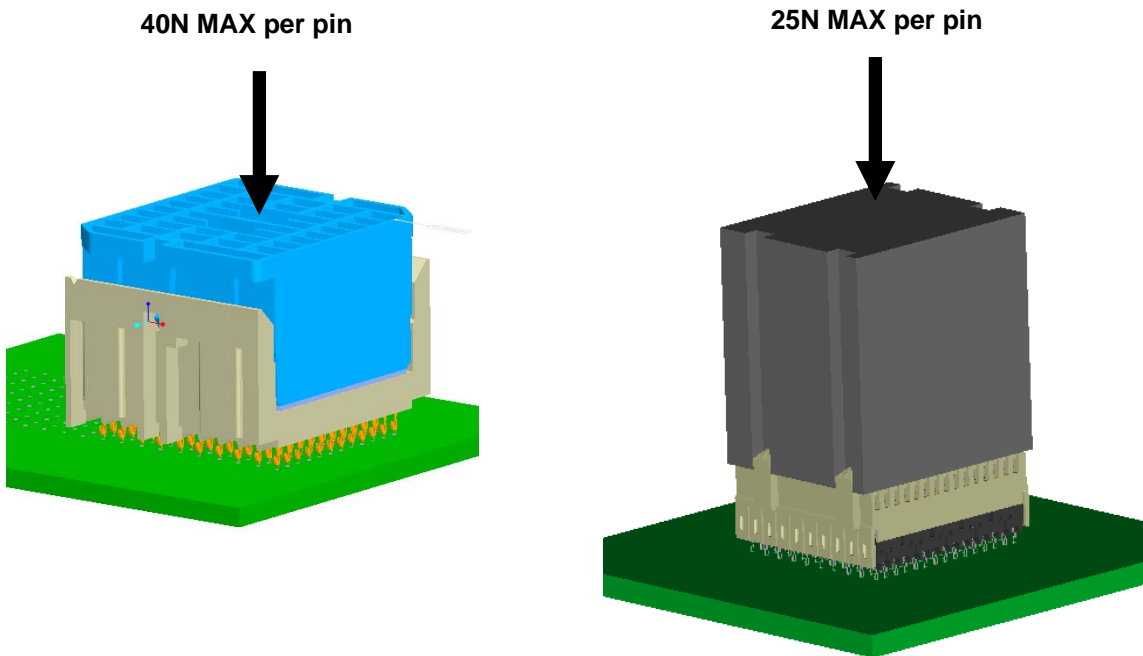

- Remove assembly from insertion press.
- Inspect product for proper application. See section 8.

NUMBER GS-20-035	TYPE APPLICATION SPECIFICATION	FCI	
TITLE AirMax VS® Connector System, press-fit products (r/a header, r/a receptacle, vertical header, vertical receptacle & orthogonal assemblies)		PAGE 29 of 33	REVISION J
		AUTHORIZED BY Tan Chen Hong	DATE 18 Aug 09
		STATUS UNRESTRICTED	

8 POST-APPLICATION INSPECTION REQUIREMENTS

Post-application inspection should consist of several simple checks to assure that the connector is applied properly and is not damaged.

- Visually assure that all press-fit tails are seated in the proper PCB holes and that none have been crushed during application.
- For right angle products, visually assure that the plastic standoffs on the bottom of each assembly are seated within 0.10 mm of flush to the PCB but not crushed. Inspect the IMLA retainer for a maximum clearance to the board of 0.10mm (see Figure 14). A larger gap beneath the standoffs or retainer may indicate that the connector is not seated fully or is not seated parallel to the board. This can cause misalignment when the daughter card is mated to the backplane.

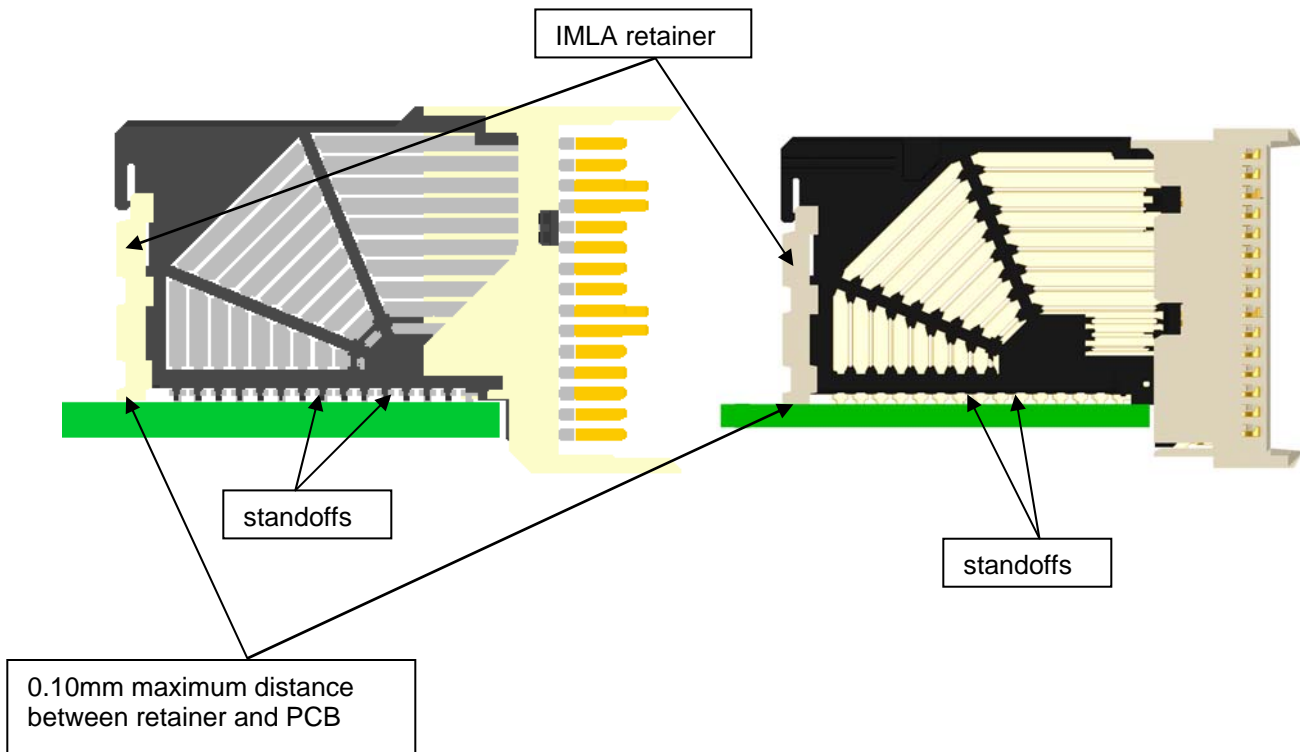



Figure 14: Proper seating depth, r/a header and r/a receptacle

NUMBER GS-20-035	TYPE APPLICATION SPECIFICATION		
TITLE AirMax VS[®] Connector System, press-fit products (r/a header, r/a receptacle, vertical header, vertical receptacle & orthogonal assemblies)		PAGE 30 of 33	REVISION J
		AUTHORIZED BY Tan Chen Hong	DATE 18 Aug 09
		STATUS UNRESTRICTED	

- For vertical headers, visually assure that the triangle cut-out and product marking correspond to the A1 position side of the PCB footprint. Also make sure any vertical connector is not over-pressed into the PCB (see Figures 15 and 16).

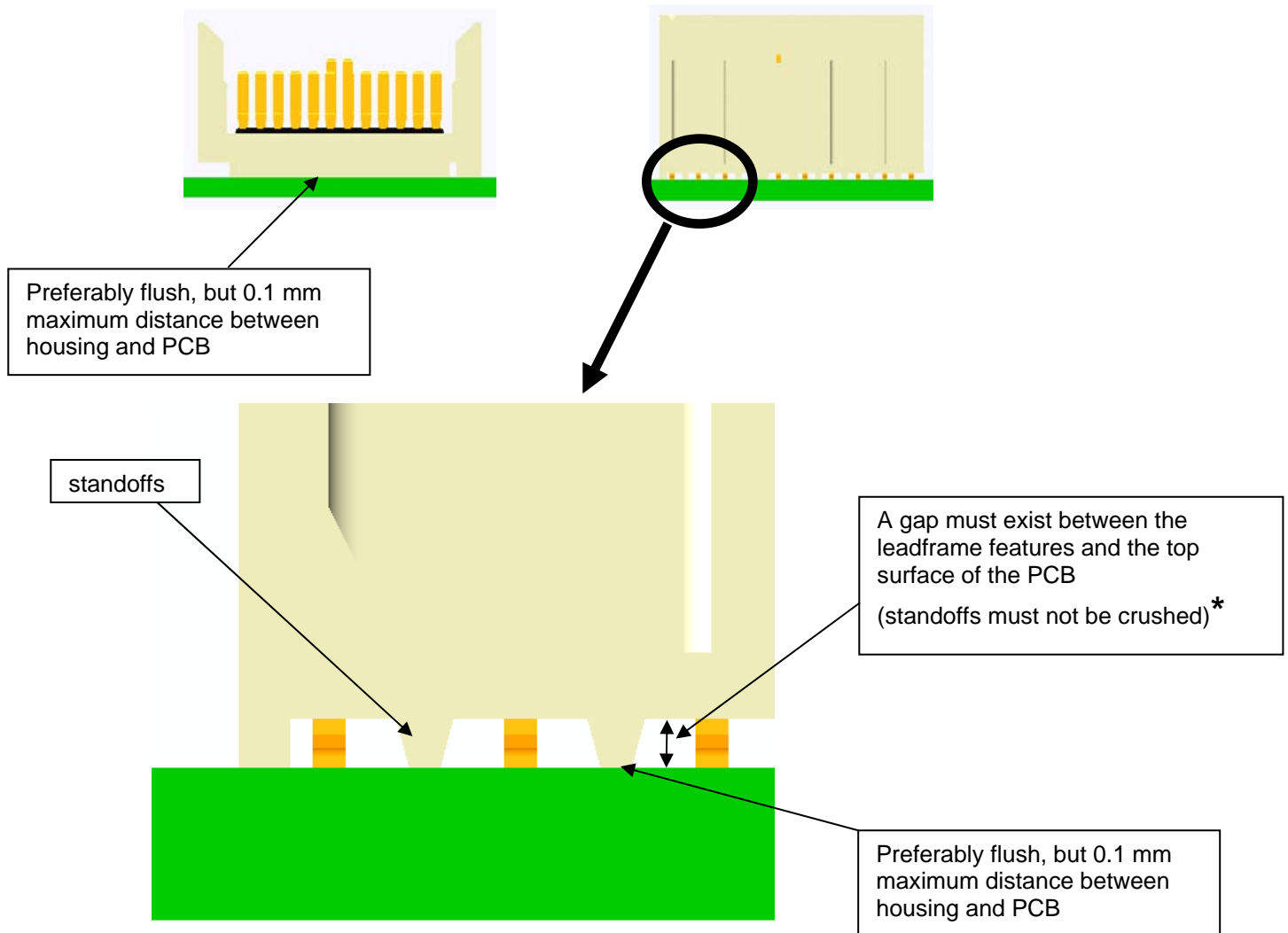



Figure 15: Proper seating depth of vertical header

*** If standoffs are over-pressed there is a risk that conductive leadframe material could make contact with the top surface of the PCB which could cause shorts between adjacent surface traces.**

NUMBER GS-20-035	TYPE APPLICATION SPECIFICATION		
TITLE AirMax VS® Connector System, press-fit products (r/a header, r/a receptacle, vertical header, vertical receptacle & orthogonal assemblies)		PAGE 31 of 33	REVISION J
		AUTHORIZED BY Tan Chen Hong	DATE 18 Aug 09
		STATUS UNRESTRICTED	

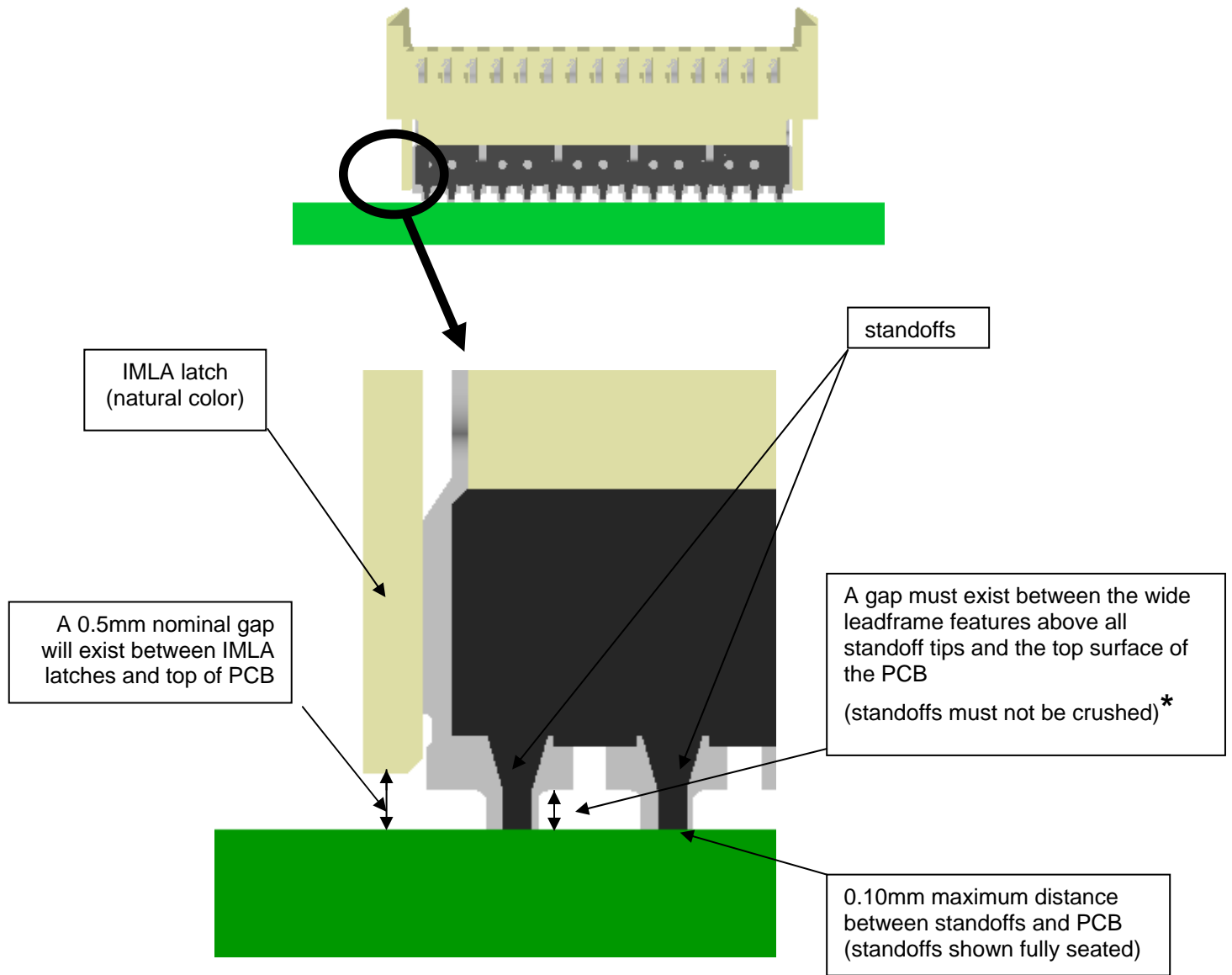



Figure 16: Proper seating depth, vertical receptacle

*** If standoffs are over-pressed there is a risk that conductive leadframe material could make contact with the top surface of the PCB which could cause shorts between adjacent surface traces.**

NUMBER GS-20-035	TYPE APPLICATION SPECIFICATION		
TITLE AirMax VS [®] Connector System, press-fit products (r/a header, r/a receptacle, vertical header, vertical receptacle & orthogonal assemblies)		PAGE 32 of 33	REVISION J
		AUTHORIZED BY Tan Chen Hong	DATE 18 Aug 09
		STATUS UNRESTRICTED	

9 CONNECTOR REMOVAL TOOLING

Following are FCI removal tool part numbers for AirMax VS[®] connectors. The referenced FCI Manuals describe proper connector removal procedures for each type of connector.

Vertical or R/A Header type	Column pitch, mm	Module width, mm	Removal tool part no. *	FCI manual no.
150-position (5 pair)	2	20 or 22	430289	430294
150-position (5 pair)	3	30 or 32	430333	
120-position (5 pair)	2	16 or 18	430336	
120-position (5 pair)	3	24 or 26	10073501	
120-position (4 pair)	2	20 or 22	10062004	
120-position (4 pair)	3	30 or 32	430307	
96-position (4 pair)	2	16 or 18	10062005	
90-position (3 pair)	2	20 or 22	430353	
72-position (4 pair)	2	12 or 14	10062006	
72-position (3 pair)	2	16 or 18	430345	
54-position (3 pair)	2	12 or 14	430340	
48-position (Orthogonal)	4.2	16.6	10080464	

Vertical or R/A Receptacle type	Column pitch, mm	Module width, mm	Removal tool part no. *	FCI manual no.
150-position (5 pair)	2	20	430278	430284
150-position (5 pair)	3	30	430342	
120-position (5 pair)	2	16	430339	
120-position (5 pair)	3	24	10073702	
120-position (4 pair)	2	20	10062007	
120-position (4 pair)	3	30	430310	
96-position (4 pair)	2	16	10062008	
90-position (3 pair)	2	20	430354	
72-position (4 pair)	2	12	10062009	
72-position (3 pair)	2	16	430346	
54-position (3 pair)	2	12	430341	
48-position (Orthogonal)	4.2	16.6	10080465	

*** To minimize costs the largest removal tool for a given column pitch may be used to remove any connector with that column pitch by disassembling the tool and removing pins as necessary.**

For some connector configurations it may be possible to use multiple repair methods. All recommended methods for repair will be described in the FCI manuals listed above.

NUMBER	GS-20-035	TYPE	APPLICATION SPECIFICATION		
TITLE	AirMax VS [®] Connector System, press-fit products (r/a header, r/a receptacle, vertical header, vertical receptacle & orthogonal assemblies)			PAGE	33 of 33
				REVISION	J
				AUTHORIZED BY	Tan Chen Hong
		STATUS	UNRESTRICTED		

REVISION RECORD

REV	PAGE	DESCRIPTION	EC #	DATE
A	all	Initial release	V04-1019	10/08/04
B	all	Added 90 posn version; modified signal densities in Table 3; Added backdrilling section 5.5	V05-0104	02/10/05
C	all	Modified document title; Added 12 row / 2 mm pith versions to all tables; Modified section 7.3; Modified section 8 and clarified Figure 8	V05-0935	10/04/05
D	all	Added r/a receptacle products; changed connector type descriptions from "rows" to "pairs"	V06-0149	02/13/06
E	all	Added paragraph 4.5, short detect pin requirements; added reference to 3 pair, 10 IMLA r/a receptacles in Tables 1 & 5	V06-0782	08/14/06
F	all	Added information for vertical headers	V06-1161	11/22/06
G	14,17, 28	Update Application Tool P/N	S06-0405	12/09/06
H	All 13,14 8 26	Added orthogonal header and r/a receptacle. And updated back-panel header new addition. Update paragraph 5.4.1 & 5.4.2 Revised Nominal Wipe Added protection cover Pliers release information	S07-0293	08/30/07
J	4 17 27	Update available Header configuration Clarify backdrilling minimum barrel length Add recommendation for compliant pin pressing speed	S09-0258	08/18/09