

NEW

Standard PC Card/ Single Slot Compatible with Card Bus

CONNECTOR

MB-0152-1

March 2006

JC22 Series

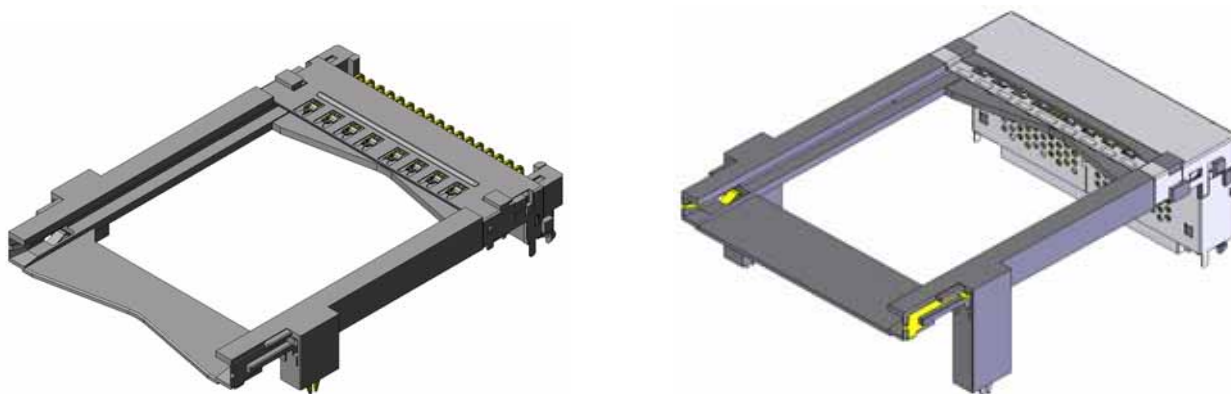

Along with the spread of digital broadcasting, installation of security modules in digital televisions etc. are rapidly speeding up.

JC22 series is a card bus connector compatible with PC card standard (Type I / II) suitable for various devices such as digital-consumer devices.

Features

- Compatible with PC Card Standard (TYPE I / II)
- DIP type-standard mounting and frame integrated structure
- Standoff height in 5mm and 17mm for effective utilization of mounting space and heat radiation
- With or without EMI shielding type is available
- Snap-in structure for easy board attachment

General Specifications

- | | |
|--|---|
| •No. of contacts: 68 pos. | •Rated current: 0.5A per pin |
| •Contact resistance:
40m ohm max. (initial)
Variation: 20m ohm max. (after test) | •Insulation resistance:
100M ohm min. (after test) |
| •Dielectric withstanding voltage:
AC 500Vr.m.s (per minute) | •Life time: 10,000 times |
| | •Operating temperature:
-20 Deg. C to 60 Deg. C |

Materials and Finishes

Components	Materials/ Finishes
Insulator	Glass filled PBT
Contact	Copper alloy/ contact area: 0.1 um min. Au plating over Ni terminal area: Sn plating over Ni
Ground plate	Phosphor bronze/ partial Au plating
Hook pin	Phosphor bronze/ Sn plating over Ni
Earth lug	Phosphor bronze/ Ni plating
Locator	Glass filled PBT
Shell	Stainless steel

Ordering Information

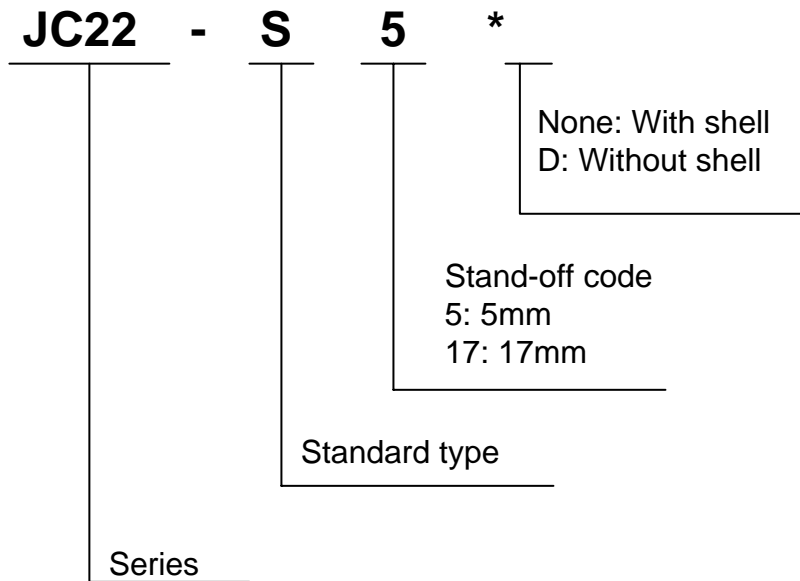

Product Drawing

JC22-S5

(Stand-off 5mm type)

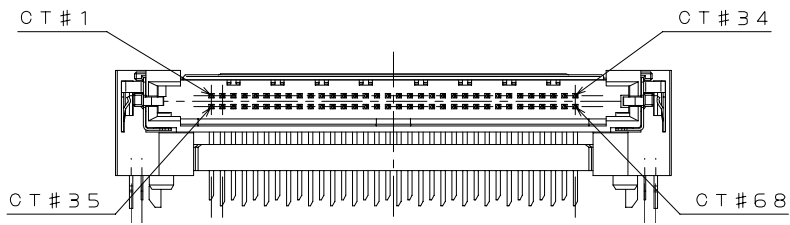
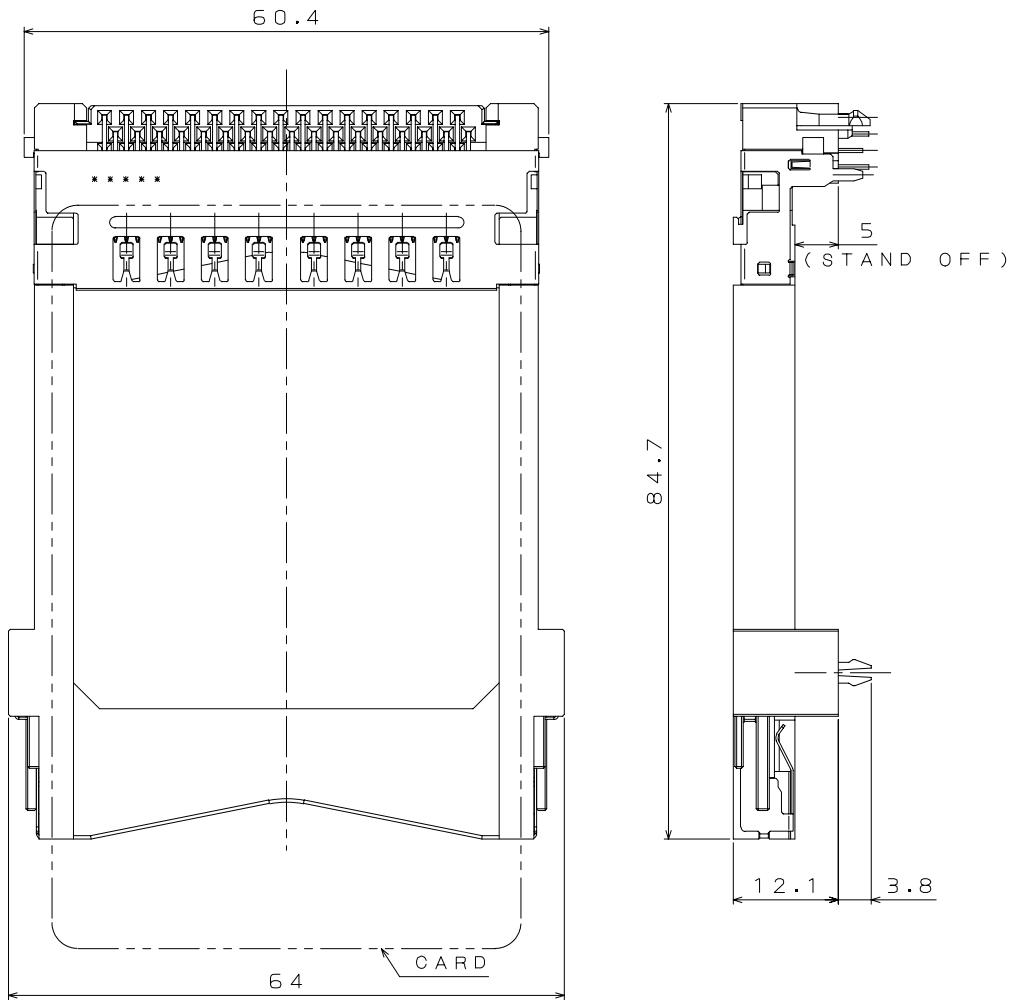

Product Drawing

■ JC22-S5

(Stand-off 17mm type, with shell)

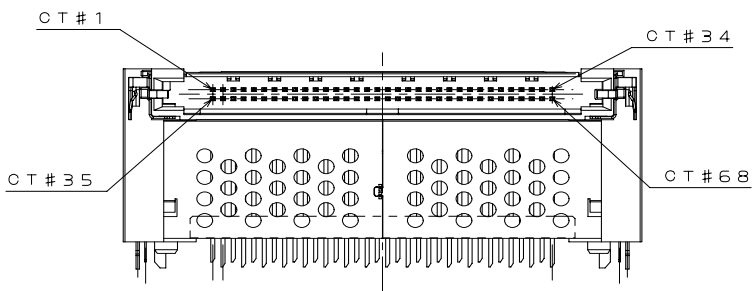
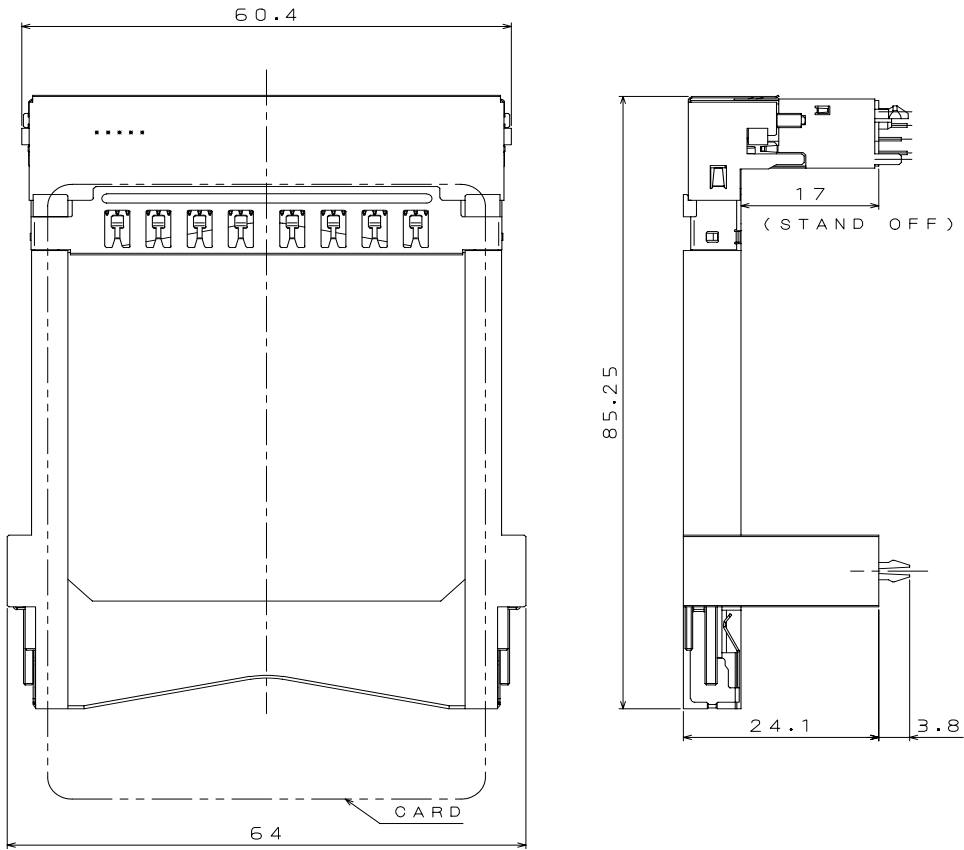

Applicable dimensions of board

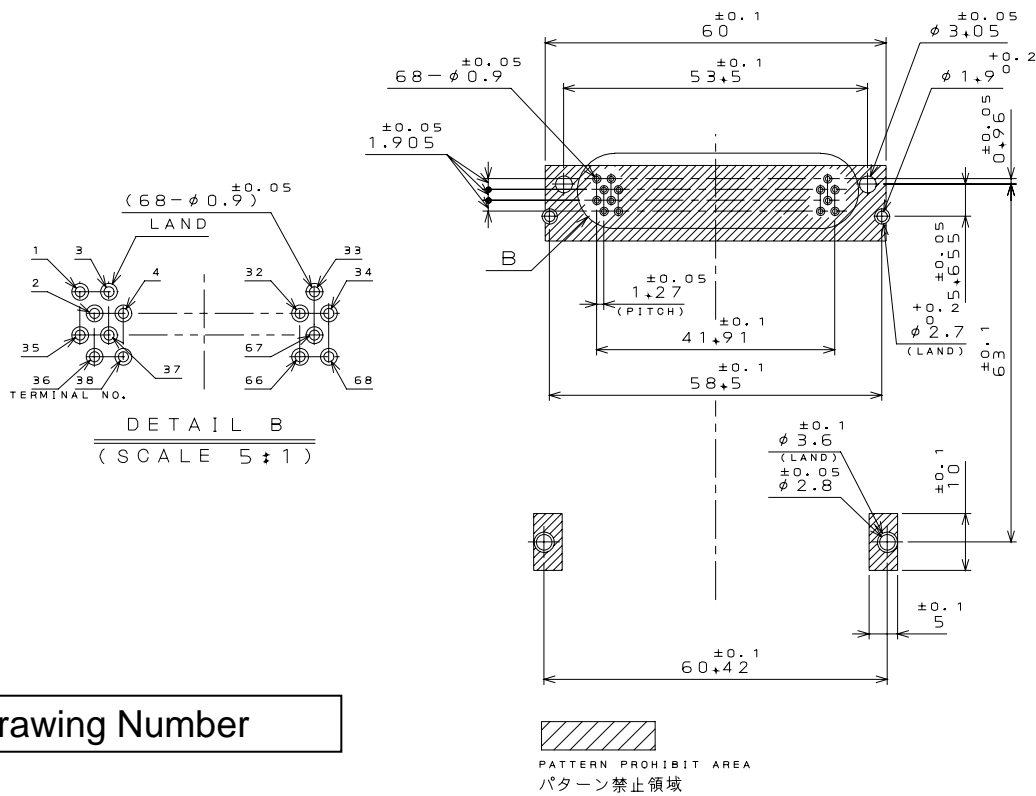

Drawing Number

Part Number	Drawing Number	Specification
JC22-S5	SJ104764	JACS-10296
JC22-S17D	SJ104765	

■ Test report: SR-C-0583

Japan Aviation Electronics Industry, Limited

Product Marketing Division
 Aobadai Building, 3-1-19, Aobadai, Meguro-ku, Tokyo 153-8539
 Phone: +81-3-3780-2787 FAX: +81-3-3780-2946

Notice: Products shown in this leaflet are made for the applications listed below. However, if the above-mentioned products are to be used in aerospace devices, marine cable-connection devices, atomic power control systems, medical equipment for life-support systems, or any other specific application requiring extremely high reliability, please contact JAE for further information.
 Recommended applications: Computers, Office machines, Measuring devices, Telecommunication devices (Terminals, Mobile devices), AV devices, Household applications, FA devices, etc.

* The specifications in this brochure are subject to change without notice. Please contact JAE for information.