

REVISIONS				
ZONE	REV	DESCRIPTION	DATE	APPROVED

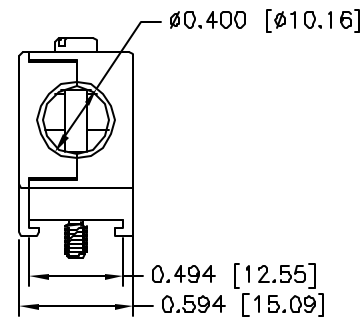

NO LOGO NORTECH LOGO

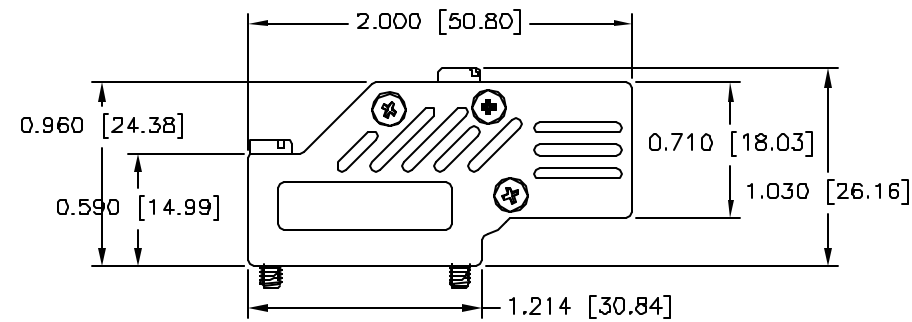
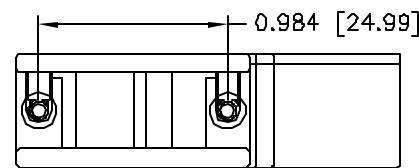

PART NUMBER INFORMATION

PART#	LOGO STYLE	SUPPLIED
NA30900000	NO LOGO	BULK
N30900000	NO LOGO	PACKAGED
NA30901000	NORTECH LOGO	BULK
N30901000	NORTECH LOGO	PACKAGED

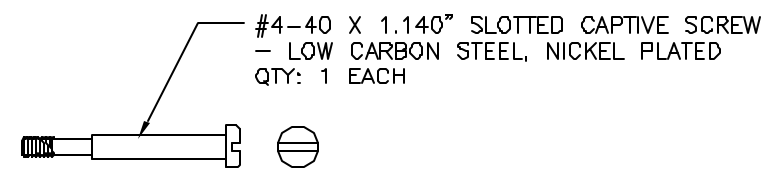
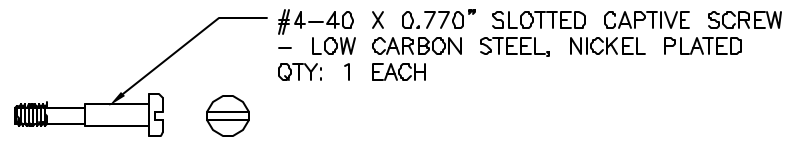
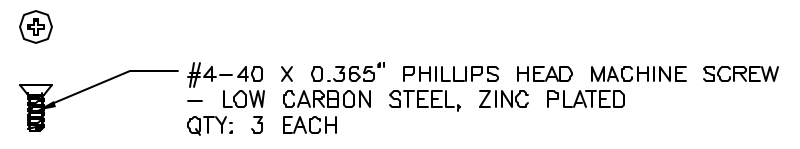
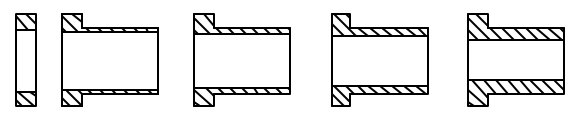
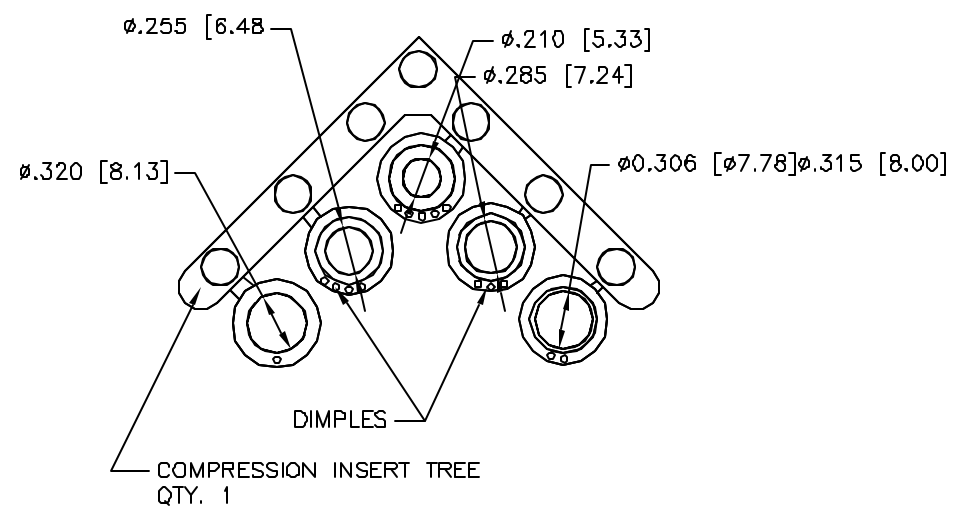

CONNECTOR COVER:

1. MATERIAL: ZINC ALLOY
2. FINISH: SEMI BRIGHT NICKEL PLATING PER NTC SPECIFICATION N/T 000400
3. DIMENSIONS: INCHES [MM]
4. TOLERANCE: ± 0.015 [0.381]

COMPRESSION INSERT TREE

1. MATERIAL: PVC UL94V-0
2. COLOR: BLACK
3. DUROMETER: 80 ± 3 TYPE A PER ASTM D2240
4. DIMENSIONS: INCHES [MM]
5. TOLERANCE: ± 0.020 [0.508]

UNLESS OTHERWISE SPECIFIED		Northern Technologies PART NUMBER SEE PART NUMBER INFORMATION DESCRIPTION CMR 09 RIGHT ANGLE ULTRA LOW PROFILE COVER			
1. ALL DIMENSIONS ARE IN INCHES AND DIMENSIONS ARE TYPICAL					
DRAWN Luis C.	18-APR-02	SIZE B	CODE 100_169	DWG NO. 0002-100-169	REV
CHECKED JSD	18-APR-02	SCALE 1:1		SHEET 1 OF 1	
ISSUED	23-APR-02				