

REVISIONS				
ZONE	REV	DESCRIPTION	DATE	APPROVED
	A	ECN 0349	16-MAY-02	

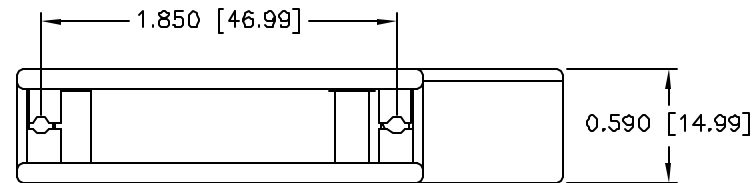

NO LOGO

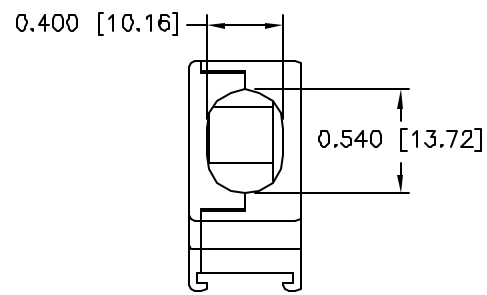
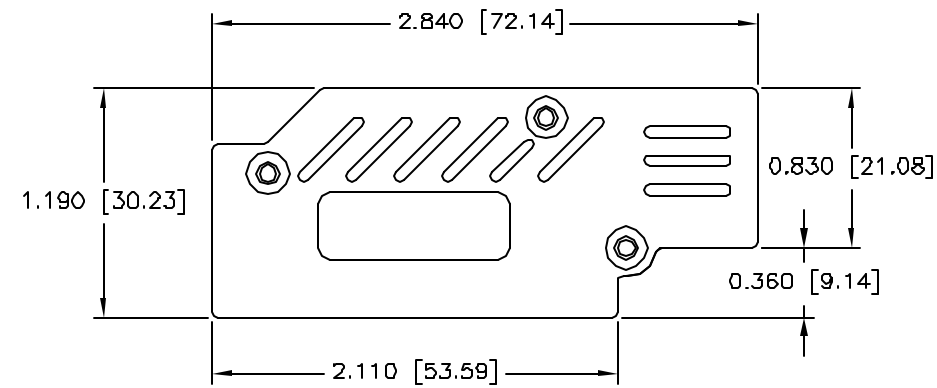

PART NUMBER INFORMATION

PART#	LOGO STYLE	SUPPLIED
NA30920000	NO LOGO	BULK
N30920000	NO LOGO	PACKAGED

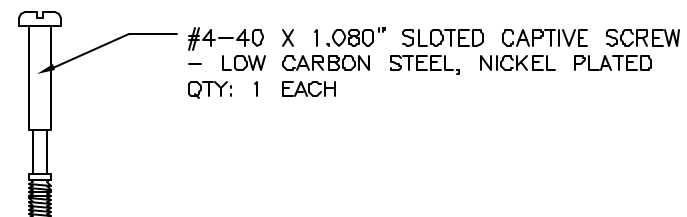
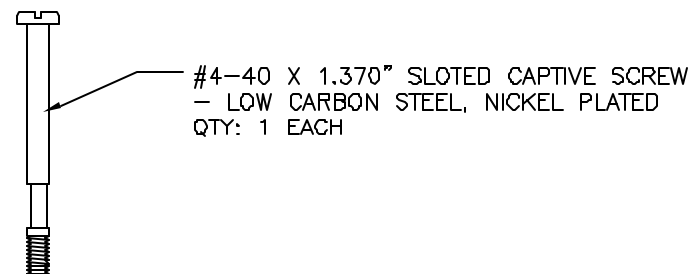
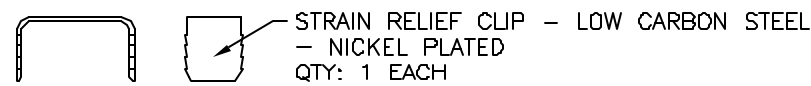
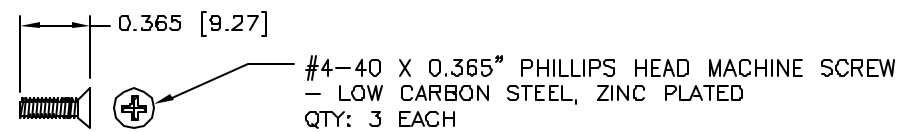

CONNECTOR COVER:

- 1.MATERIAL: ZINC ALLOY
- 2.FINISH: SEMI BRIGHT NICKEL PLATING PER NTC SPECIFICATION N/T 000400
- 3.DIMENSIONS: INCHES [MM]
- 4.TOLERANCE: ±0.015 [0.381]

UNLESS OTHERWISE SPECIFIED		<b>Northern Technologies</b> <small>THIS DRAWING IS THE PROPERTY OF NORTHERN TECHNOLOGIES AND SHOULD NOT BE REPRODUCED WITHOUT NORTHERN TECHNOLOGIES WRITTEN PERMISSION</small>		
<small>1. ALL DIMENSIONS ARE IN INCHES (MM) 2. DIMENSIONS ARE TYPICAL</small>				
DRAWN Luis C.		PART NUMBER SEE PART NUMBER INFORMATION		
23-JAN-02		DESCRIPTION CMR 25 RIGHT ANGLE - LOW PROFILE COVER		
CHECKED JSD	12-FEB-02	SIZE B	CODE 100_108	DWG NO. 0002-100-108
ISSUED	12-FEB-02	SCALE 1:1		REV
				SHEET 1 OF 1