

# Industrial Interconnect Overview

3M™ Electronics Materials Solutions Division

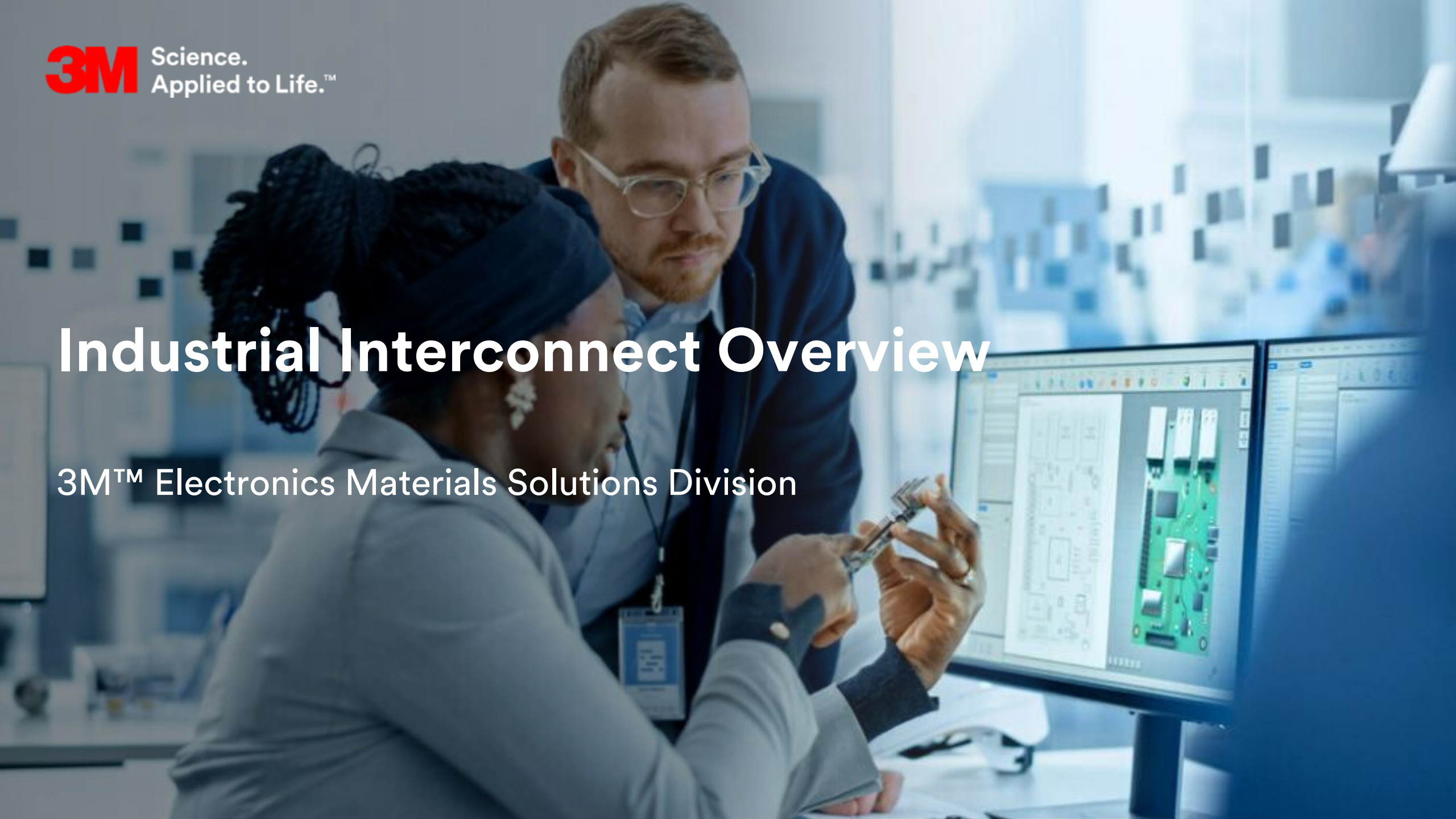

# 3M™ Interconnect Product Portfolio

A scientist in a white lab coat is seated at a workstation in a laboratory or office environment. He is looking down at a small component in his hands, possibly a connector or cable assembly. The workstation includes two computer monitors displaying technical data and circuit diagrams, a keyboard, and a mouse. The background shows other lab equipment and a bright, modern setting.

**3M Input / Output  
Connectors**

**3M Wire- & Board-mount  
Connectors**

**3M Industrial Cables**

**3M Cable Assemblies**

**3M Memory Card Headers**

# Table of Contents

## 1. [3M Wire- and Board-mount Connectors](#)

- [3M Boardmount Headers](#)
- [3M Wiremount Sockets](#)
- [3M™ Mini Clamp Connectors](#)
- [3M™ Power Clamp Connectors](#)
- [3M™ Link Connectors](#)
- [3M™ Mini Stack Connectors](#)

## 2. [3M Industrial Cable Portfolio](#)

## 3. [3M Input/Output Connectors](#)

- [3M Dsub Connectors](#)
- [3M MDR Components](#)
- [3M SDR Connectors](#)
- [3M SCR Connectors](#)
- [3M 2mm IEEE 1394 Connectors](#)

## 4. [3M Memory Card Headers](#)

## 5. [3M Cable Assemblies](#)

- [3M™ Molded Assemblies](#)
- [3M™ USB3 Vision Camera Cable Assemblies](#)
- [3M™ MDR Cable Assemblies](#)
- [3M™ SDR Cable Assemblies](#)
- [3M™ Internal TwinAx High Speed Cable Assemblies](#)
- [3M™ External TwinAx High Speed Cable Assemblies](#)

# 3M Wire- and Board-Mount Connectors

# 3M™ Connector and Cable Mating Guide

## Digital Cable Guide

<b>Connectors</b>					
<b>Connector Pitch</b>	2.54mm x 2.54mm (0.100" x 0.100")	2.00mm x 2.00mm (0.079" x 0.079")	1.27mm x 2.54mm (0.050" x 0.100")	1.27mm x 1.27mm (0.050" x 0.050")	1.27mm x 1.27mm (0.050" x 0.050")
<b>Header Series</b>	3M™ Four-Wall Headers and PCB Connectors	3M™ Shrouded Boardmount Header	3M™ Tripolarized Header	3M™ Shrouded Boardmount Header	3M™ Mini Delta Ribbon (MDR) Connector
	2500, 3000, 4600, 78XX, 303XX	1552	810	452	101, 103 (Shell)
<b>Socket Series</b>	3M™ Wiremount Socket	3M™ Ribbon Cable Socket	3M™ Tripolarized Wiremount Socket	3M™ Ribbon Cable Wiremount Socket	3M™ Mini Delta Ribbon (MDR) Connector
	3000, 891, CHG, 7964	1522	820	451	102
<b>Cables</b>					
<b>Cable Pitch (if flat)</b>	0.050"	1mm	0.025"	0.025"	0.025"
<b>Basic Cable Series #</b>	3365	3625	3754	3754	3600
<b>3M™ Round Conductor Flat Cable</b>	3365, 3667, 3539, 3319, 3801, 3355, 3770, HF365, 3601	3625, HF625, 3250	3754, 3447, 3756, 3749, 3609, 3604 HF447, 7700	3754, 3447, 3756, 3749, 3609, 3604, HF447, 7700	3754, 3447, 3756, 3749, 3609, 3604
<b>3M™ Color Coded Flat Cable</b>	3302, 3811				
<b>3M™ Twisted Pair Flat Cable</b>	1700, HF100				
<b>3M™ Jacketed Flat Ribbon Cable</b>	3603, 3602, 3517, 90104, 90204, HF017		90111, 90101, 90202, 90201, 90211, 93101	90111, 90101, 90202, 90201, 90211, 93101	90111, 90101, 90202, 90201, 90211, 93101
<b>3M™ Round Jacketed Flat Cable</b>	3759, 3758, 3659, HF759, HF659		3896	3896	3896
<b>3M™ Twisted Pair Round Jacketed Cable</b>	3600B, 3644, 3647, 3750 HF644				3600B, 3644, 3647B, 3750 HF644



**3M** Science. Applied to Life.™

Cables and Accessories Selection guide.

**Power inside.**

### 3M™ Flex Cycles

Each of the three cables represented in this chart consist of 28 AWG stranded conductors on 0.050" (1.27mm) wire spacing.

The 3M 3319/HF319/3250 cable represents conductors which consist of 19 strands, in which each of the strands are 40 AWG silver plated high-strength copper alloy (ex. at 7/8" bended radius = ~100 million flexes cycles).

The 3M 3539/HF539 cable represents conductors which consist of 19 strands, in which each of the strands are 40 AWG tinned soft copper (ex. at 7/8" bended radius = ~10 million flexes cycles).

The 3M 3365/HF365 cable represents conductors which consist of 7 strands, in which each of the strands are 36 AWG tinned soft copper (ex. at 7/8" bended radius = ~1 million flexes cycles).

The "Stiffing Flex Test" forced the cable 180° around a radius closely resembling typical usage, as represented in the illustration to the right. For more details download the tech sheet TS-0732.

### AWG conversion table

AWG	Stranded Wires		Conductor	
	Number	Outside Diameter (mm/inch)	Outside Diameter (mm/inch)	Cross Section
22	1	0.843/0.0233	0.84/0.0233	0.326/840
	7	0.254/0.0100	0.78/0.0250	0.355/700
	19	0.180/0.0083	0.81/0.0202	0.382/750
24	1	0.810/0.0201	0.81/0.0201	0.205/404
	7	0.203/0.0080	0.81/0.0204	0.227/448
	19	0.127/0.0050	0.84/0.0250	0.241/475
26	1	0.804/0.0199	0.40/0.0159	0.128/253
	7	0.180/0.0083	0.48/0.0190	0.141/275
	19	0.102/0.0040	0.51/0.0200	0.149/304
28	1	0.520/0.0128	0.52/0.0128	0.080/124
	7	0.127/0.0050	0.38/0.0150	0.099/175
	19	0.080/0.0031	0.40/0.0180	0.092/201
30	1	0.280/0.0100	0.25/0.0100	0.050/100
	7	0.102/0.0040	0.30/0.0120	0.057/112

### 3M™ Flat Ribbon Cable

Ask your local 3M contact.

# 3M™ Wire- and Board-mount Connectors

Almost anywhere signal-based control is a requirement.  
Connecting two boards or board to peripheral device.

## Applications/Wins:

- Test and measurement
- Factory/Industrial Automation
- Power to signal boards
- Robotics
- Appliances
- Communication equipment
- Office Equipment
- Patient monitoring
- In-vehicle entertainment
- HVAC
- Displays

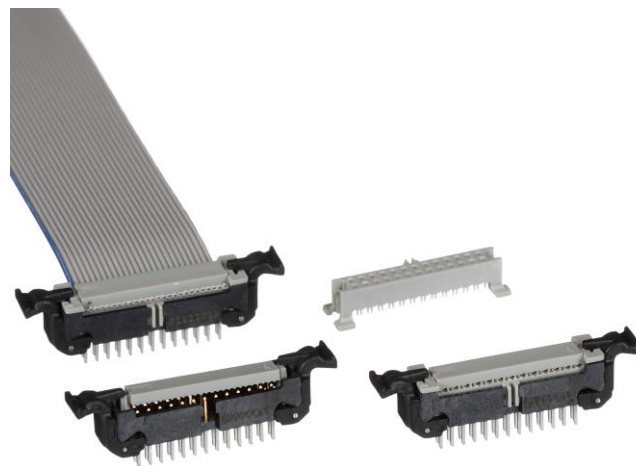

[Application Flyer](#)

# 3M Board-mount Headers

# 3M™ Four-Wall Header 2500 Series (0.100" pitch)

## Key Features:

- Low profile, space saving design
- High temperature insulator suitable for "no lead" soldering operations
- Center slot polarization prevents mis-insertions and reduces insertion time
- Dual slot polarization means broader compatibility with competitive polarization designs
- Suitable for reflow soldering using "paste in hole" techniques



3M Mating Socket	Note
<a href="#">3000</a>	Premium socket
<a href="#">891</a>	Cost competitive
<a href="#">CHG</a>	Higher AWG discrete wire



# 3M™ Four-Wall Header 3000 Series (0.100" pitch)

## Key Features:

- Military (with 3M's N3518 polarizing key) and center bump polarization
- Optional ejector latches – long / short
- Mounting holes for securing header to board
- Optional polarizing posts available
- High temperature insulator option suitable for "no lead" soldering operations
- Suitable for reflow soldering using "paste in hole" techniques
- Solder tail option

3M™ Four-Wall Header Straight and Right Angle 3000 Series



3M™ Four-Wall Condo Header 3000 Series



3M™ Four-Wall Header Straight Compliant Pin 3000 Series

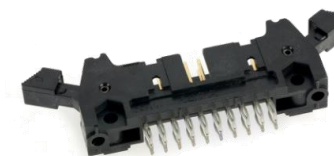

- [3000 Series Product Page](#) (4 wall)
- [3000 Series Product Page](#) (4 wall Condo)
- [3000 Series Product Page](#) (4 wall Pin Compliant)

3M Mating Socket	Note
<a href="#">3000</a>	Premium socket
<a href="#">891</a>	Cost competitive
<a href="#">CHG</a>	Higher AWG discrete wire

[Cable Mating Guide](#)

# 3M™ Three-Wall Header 3000 Series (0.100" pitch)

## Key Features:

- Military (with 3M's N3518 polarizing key) and center bump polarization
- Optional ejector latches – long / short
- Mounting holes for securing header to board
- Optional polarizing posts available
- High temperature insulator option suitable for "no lead" soldering operations
- Suitable for reflow soldering using "paste in hole" techniques
- Solder tail option

3M™ Three-Wall Header  
3000 Series



3M™ Three-Wall Condo  
Header, 3000 Series



[3000 Series Product Page](#) (3 wall)

[3000 Series Product Page](#) (3 wall condo)

3M Mating Socket	Note
<a href="#">3000</a>	Premium socket
<a href="#">891</a>	Cost competitive
<a href="#">CHG</a>	Higher AWG discrete wire

[Cable Mating Guide](#)

# 3M™ Wiremount Plug 4600 Series (.100" pitch)

## Key Features:

- Military (with 3M's N3518 polarizing key) and centerbump polarization
- Shrouded to protect against physical and chemical pin damage
- Open or closed end covers available
- Optional ejector latches
- Accepts flat cable or discrete wire
- Optional mounting flanges
- Optional metal strain relief



3M Mating Socket	Note
<a href="#">3000</a>	Premium socket
<a href="#">891</a>	Cost competitive
<a href="#">CHG</a>	Higher AWG discrete wire

# 3M™ PCB, 78XX Series (.100" pitch)

## Key Features:

- Low profile, space saving design
- Single connector termination reduces overall connector cost
- 7.3 mm terminated height for applications requiring low-profile off the board
- Solder bumps facilitate board cleaning
- Fits standard .100" x .100" header layout

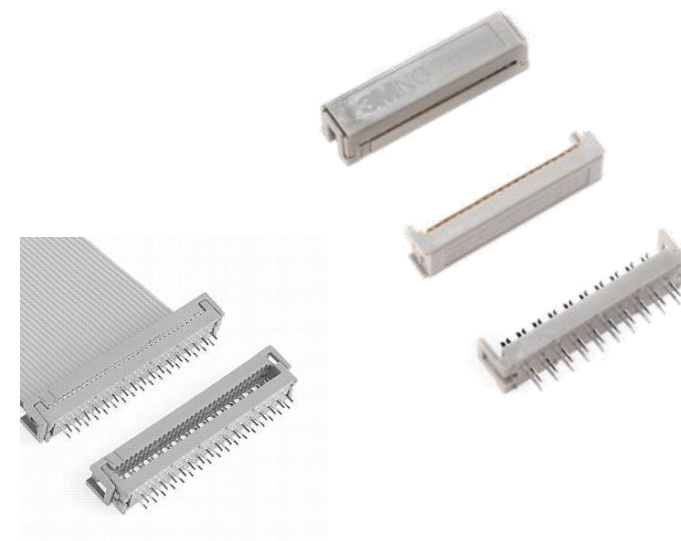

3M Mating Socket	Note
N/A	Direct to board

# 3M™ Low Profile Header, 303 Series (0.100" pitch)

## Key Features:

- Low profile sturdy body
- Gold Flash
- End Windows
- Straight or right angle
- Ejector latch option

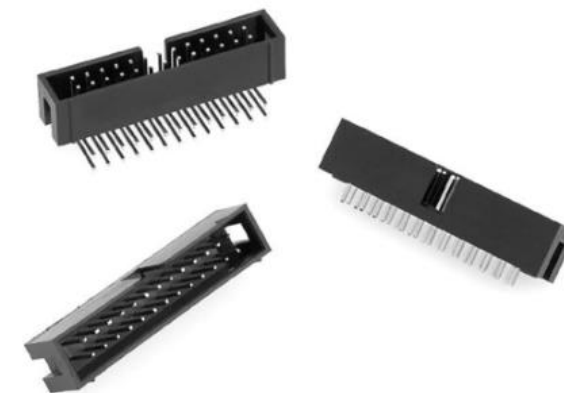

3M Mating Socket	Note
<a href="#">3000</a>	Premium socket
<a href="#">891</a>	Cost competitive
<a href="#">CHG</a>	Higher AWG discrete wire

# 3M™ Latch/Eject Header, 1552 Series (2mm pitch)

## Key Features:

- 14 pin counts ranging from 6 to 50 positions
- Latch/eject mechanism securely latches to socket
- Roll pins retain latches to body in shipping and high vibration environments
- High temperature insulators suitable for "lead free" processing and meet JEDEC J-STD-020
- Robust system solution when used with 3M™ IDC Wiremount Sockets or 3M™ Molded Cable Assemblies
- SMT latch/eject headers are available in tape and reel with vacuum cap for automatic placement

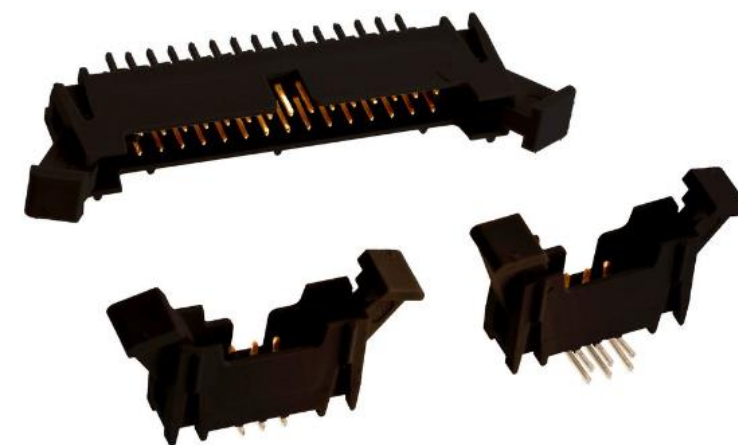

3M Mating Socket	Note
<a href="#">1522</a>	Industry Standard Compatible

# 3M™ 4-Wall Header, Tripolarized Header 810 Series (0.05" pitch)

[Back to index](#)

## Key Features:

- Tripolarized to mating socket
- 50 mil x 100 mil halves the connector length
- Latch and eject for rugged high-performance applications
- Available for through hole or surfacemount attachment
- High temperature plastic
- Straight and right-angle
- Contacts: 20, 26, 36, 40, 50, 60, 68, 80 and 100

Right-angle



Straight



3M Mating Socket	Note
<a href="#">820</a>	Tripolarized wiremount socket

# 3M™ Shrouded Boardmount Header 1.27 mm (0.050 in) Pitch Latch and Eject 452 Series

[Back to index](#)

## Key Features:

- Delivers high connection density for ribbon cable applications
- Extremely small 1.27mm (0.050") pitch saves space
- Available friction latching and ejection system enables reliable connections in challenging environments
- UL and CUL Listed
- Low profile latch/eject allows dual sided PCB reflow

## Applications/Wins:

- Almost anywhere signal-based control is a requirement and space is at a premium
- [Application flyer](#)

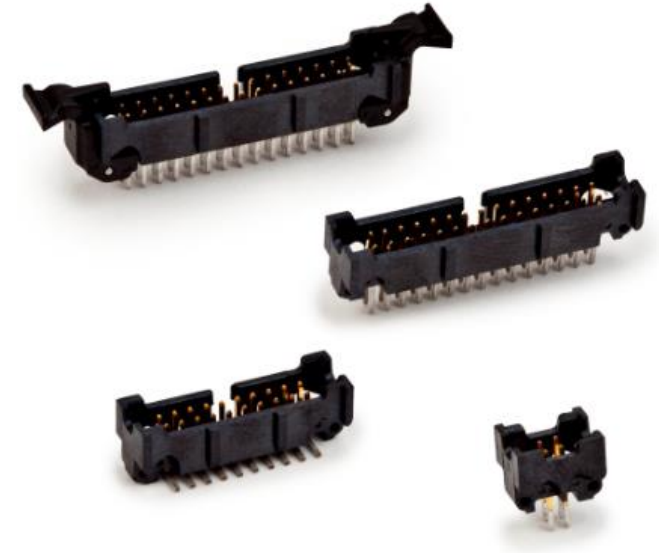

3M Mating Socket	Note
<a href="#">451</a>	Space saving wire-to-board system



# 3M Wire-mount Sockets

# 3M™ Wiremount Socket, 3000 Series (.100" pitch)

## Key Features:

- Industry standard IDC socket
- Positive locking metal "J" clips provide high cover retention
- Quick connect/disconnect capability, fast termination
- Open or closed end covers available
- Accepts flat cable or discrete wire
- Military polarization, with or without centerbump
- Strain relief options
- RoHS compliant

3M™ Wiremount Socket  
Preassembled 3000 Series



3M™ Wiremount Socket, w/  
Optional Plastic or Metal  
Strain Relief, 3000 Series



[3000 Series Product Page](#) (Preassembled)  
[3000 Series Product Page](#) (Standard)

3M Mating Header	Note
<a href="#">2500</a>	Low profile header
<a href="#">3000 (4 wall)</a>	Latch eject system
<a href="#">3000 (3 wall)</a>	Latch eject system, design flexibility
<a href="#">4600</a>	Wiremount plug
<a href="#">303</a>	Cost effective

[Cable Mating Guide](#)

# 3M™ IDC Ribbon Cable Socket, 891 Series (0.100” pitch)

## Key Features:

- Wiremount socket, IDC, preassembled
- Preassembled, terminates faster than two-piece sockets
- Sword packaging makes easy loading of manual and semi-automatic assembly equipment
- Bumps prevent premature latch locking during shipment
- Optional double-sided adhesive pull tab for easy unplugging
- Double-recessed cover for cable terminating from either side eliminates need for single-recessed cover connectors

3M™ IDC Ribbon Cable Socket, 891 Series



3M™ Wiremount Socket 79 Series



3M Mating Header	Note
<a href="#">2500</a>	Low profile header
<a href="#">3000 (4 wall)</a>	Latch eject system
<a href="#">3000 (3 wall)</a>	Latch eject system, design flexibility
<a href="#">4600</a>	Wiremount plug
<a href="#">303</a>	Cost effective

[7964 Series Product Page](#) (64 position)

[891 Series Product Page](#)

# 3M™ Wiremount Socket, CHG Series (0.100" pitch)

## Key Features:

- Twin slot IDC provides four points of contact
- Exclusive L/H 4-wipe contact
- 3435-0 keying plug is optional - order separately
- Mates to 3M pin strip headers



3M™ Pak 100 Polarized Wiremount Socket, CHG Series



3M™ Wiremount Socket .100" X .100", CHG-10XX-001010-KXX, CHG Series



3M™ Wiremount Socket CHG-20XX-001010-KXX CHG Series

[CHG Pak 100 Product Page](#) (2 row polarized body, Military/DIN 41612)

[CHG-20 Product Page](#) (2 row, side-to-side stackable)

[CHG-10 Product Page](#) (1 row, side-to-side stackable)

3M Mating Header	Note
<a href="#">2500</a>	Low profile header
<a href="#">3000 (4 wall)</a>	Latch eject system
<a href="#">3000 (3 wall)</a>	Latch eject system, design flexibility
<a href="#">4600</a>	Wiremount plug
<a href="#">303</a>	Cost effective

[Cable Mating Guide](#)

# 3M™ Wiremount Socket, 1522 Series (2mm pitch)

## Key Features:

- Industry standard compatible
- Mates with Pak 20 (2 mm x 2 mm) grid pin strips
- Low profile
- Preassembled covers
- Available with or without strain relief
- Available with optional centerbump polarity feature



3M Mating Header	Note
<a href="#">1552</a>	Industry Standard Compatible

# 3M™ Tripolarized Wiremount Socket, 820 Series (0.050" X 0.100")

[Back to index](#)

## Key Features:

- Tripolarized to help prevent damage when mating to 810 Series Header
- 50 mil x 100 mil halves the connector length vs. traditional 100 mil x 100 mil products
- Hill-n-dale design provides a high-performance IDC termination and improved signal integrity vs. planar terminated connectors
- Beryllium Copper alloy contacts for superior strength and reliability
- Metal cover latch for positive cover retention and long term reliability
- Metal strain relief for increased reliability and durability
- Contacts: 20, 26, 36, 40, 50, 60, 68, 80 and 100

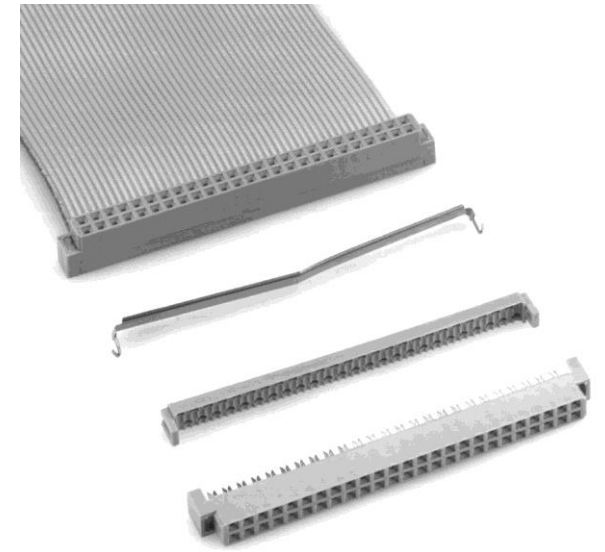

3M Mating Header	Note
<a href="#">810</a>	Tripolarized wiremount header

# 3M™ Ribbon Cable Wiremount Socket 1.27 mm (0.050 in) Pitch 451 Series

[Back to index](#)

## Key Features:

- Delivers high connection density to ribbon cable applications
- Extremely small .050"/1.27mm pitch saves space
- Enables cable end and feed through termination as well as mass termination
- Available friction latching and ejection system enables reliable connections in challenging environments
- UL & CUL Listed
- Available position counts: 4, 6, 8, 10, 12, 14, 16, 20, 26, 30, 40, 50

## Applications/Wins:

- Almost anywhere signal-based control is a requirement and space is at a premium
- [Application flyer](#)



**3M Mating  
Header**

**Note**

[452](#)

Space saving wire-to-board system

[451 Series Product Page](#)

© 3M 2023. All Rights Reserved. 3M Confidential.



[Cable Mating Guide](#)

# 3M™ Mini-Clamp Connectors



# 3M™ Mini-Clamp Connectors

3M Mini-Clamp Connectors are designed to provide connection reliability and cost performance in I/O applications commonly found in a wide range of sensor control systems, including Factory Automation and Industrial Controls

## Benefits:

- Labor savings
- Easy field termination

## Wins/Applications:

- Industrial controls
- Packaging/Conveyor Systems
- Test and measurement
- Elevator controls
- LED lighting

## Time Savings

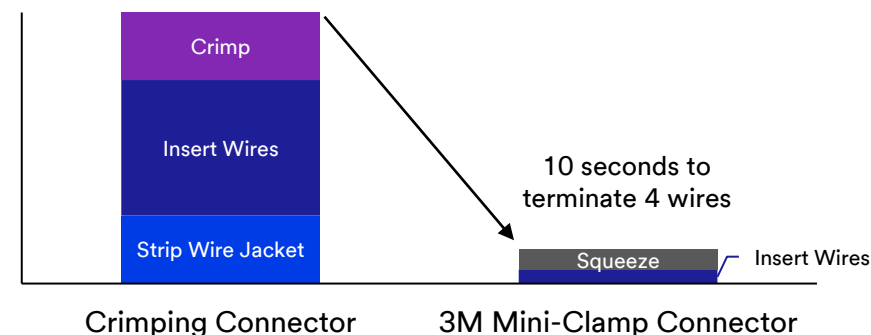

## Application Example

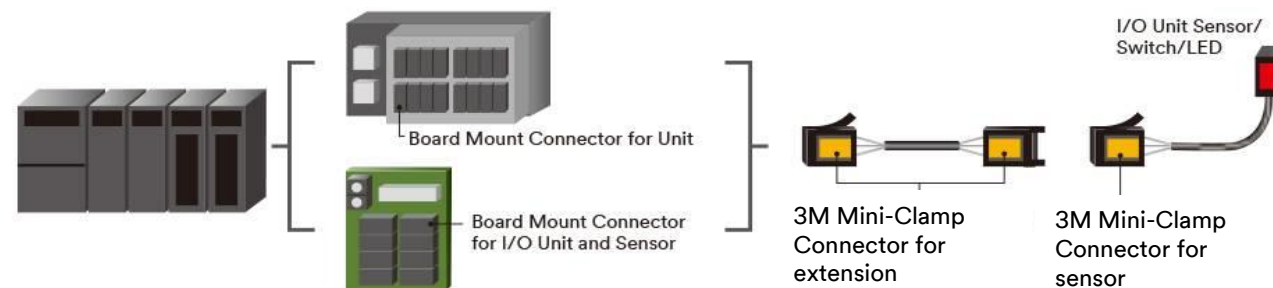

# 3M™ Mini-Clamp Connectors

## Key Features:

- Compact design saves board and panel space
- Reduces maintenance work by providing higher connection reliability
- Easy, quick, and reliable IDC termination using a standard pliers
- Offers time and labor savings - 10 seconds to terminate 4 wires
- Enables easy field termination
- No need to strip wire insulation; Less waste, saves time and helps prevent wire damage
- High number of mating cycles



3M™ Mini-Clamp Plug



3M™ Mini-Clamp Socket



3M™ Mini-Clamp Common Socket



3M™ Water-Resistant Boot (IP67)



3M™ Mini-Clamp Socket

## Termination Process



Insert wires with insulation

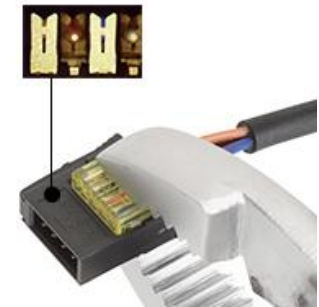

Squeeze with pliers

# 3M™ Link Connectors

# 3M™ Link Connectors

3M™ Link Connectors offer a simple, single-action IDC termination for T-branching and splicing of sensor and field networks. Available in standard detachable, One Piece, and Branch Mini-Clamp versions.

## Benefits:

- Enables branched networks and splicing into an existing network
- Provides networking efficiency by optimizing signal and power line routing to terminal
- Allows installation of additional small devices without adding signal and power lines from controls

## Wins/Applications:

- Parking Garage Sensors

## Serial Sensor Network Example

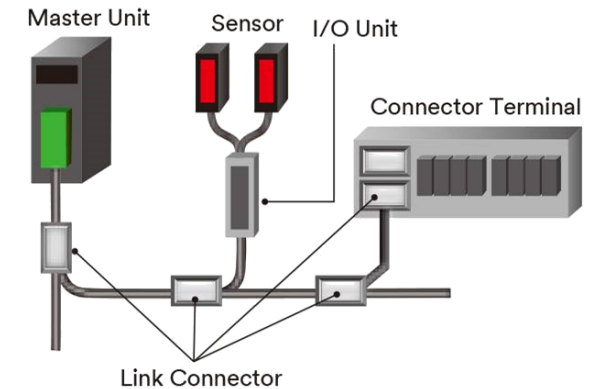

## Power Supply Example

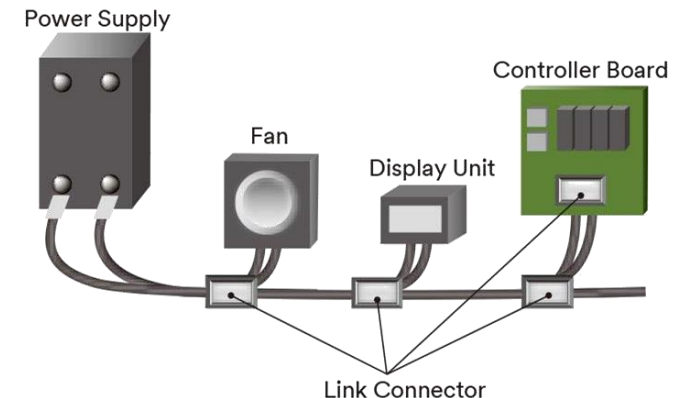

# 3M™ Link Connectors

## Key Features:

- Enables branching from main wire to branch wire in the field with no special equipment
- Easy, labor saving and reliable IDC termination
- Single-action IDC termination connector for T-branching and splicing of sensor and field networks
- Easy field termination with no special wire preparation – no stripping, tinning or special tooling
- Ability to install wire-saving system
- Simple, reliable connection



3M™ Link Connector,  
381 Series



3M™ Link Connectors,  
382 Series



3M™ One Piece Branch Link  
Connector, 387 Series



3M™ Branch Mini-Clamp  
Link Connectors, 38A Series

## Termination Process



Just insert wires with  
insulation and squeeze with  
a pair of pliers



T branch by connector

# 3M™ Power Clamp Connectors

# 3M™ Power Clamp Connectors

3M™ Power Clamp Connector is a quick-termination connector for field networking applications and protocols. The simple IDC installation process allows for labor savings and high connection reliability. It is compatible with CLPA's CC-Link open technology.

## Benefits:

- Splicing adaptor with fast, reliable installation
- Smaller connector size than most standard screw-type alternatives
- Supports 250Volts, 10A (1 line), 7A max (all lines)
- Supports 20 to 18 AWG wire
- Compatible with CC-Link Communication Interconnect Standard



Example



# 3M™ Power Clamp Connectors

## Key Features:

- Utilizes IDC technology
- Easy, labor saving, and reliable IDC termination
- Easy field termination with no special tooling or wire preparation – no stripping or tinning
- Robust latching mechanism maintains a reliable interconnection in demanding field applications
- Requires only one hand to mate and unmate for field maintenance ease
- Polarization ensures proper interconnecting of mated pairs
- CC-Link Communication Interconnect Standard



3M™ Power Clamp Wiremount Socket



3M™ Power Clamp Wiremount Plug



3M™ Power Clamp Header (Straight or R/A)



3M™ Power Clamp Branch Connector (H & Y Type)

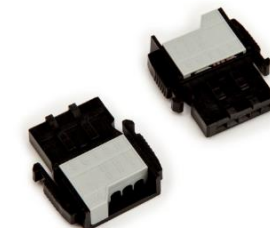

3M™ Power Clamp Terminator

## Termination Process



Just insert wires with insulation



Squeeze with a pair of standard pliers



# 3M™ Mini Stack Connectors

# 3M™ Mini Stack Connectors

The 3M™ Mini Stack Connector provides a reliable connection with a simple termination process while reducing the required board footprint.

## Benefits:

- Space-saving: Saves 30% more board space in comparison with 3M™ Mini-Clamp Connectors
- Time-saving: Reduces wiring time by approx. 60% compared to crimping connectors\*
- Compact with simple termination
- Compact with easy mating/unmating

\* Compared to similar sized crimped connector with 3 pins (based on 3M evaluation and while using 3M™ Mini Stack Hand Tool)

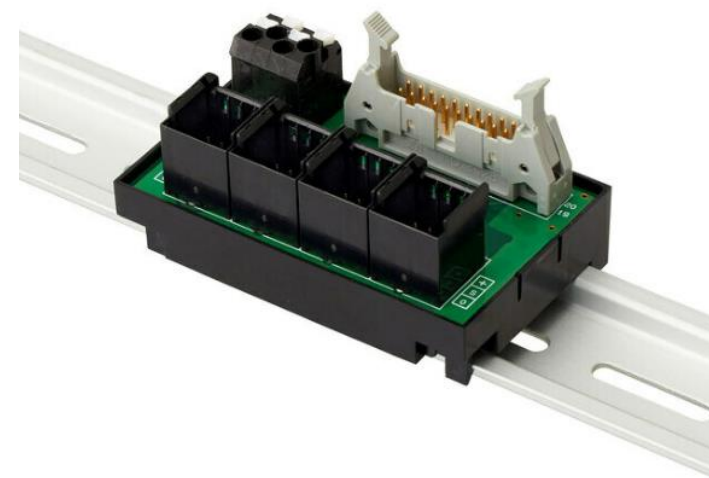
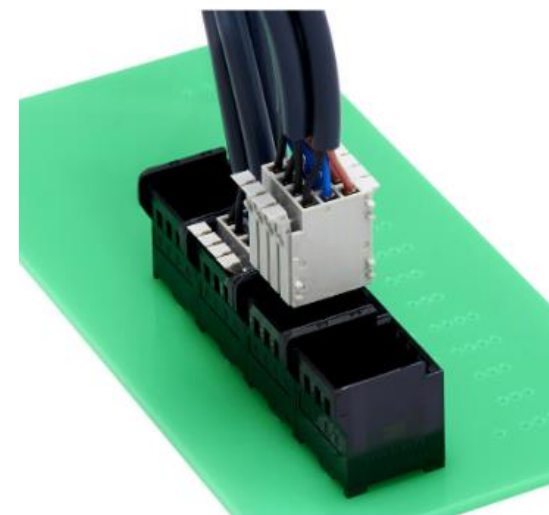

# 3M™ Mini Stack Connectors

## Key Features:

- Provides excellent wire connections in a compact form
- No pre-treatment of wire needed with IDC technology
- Terminates 2 or 4 wires in single action
- Integrated terminals and housing make handling easy
- Wide range of wire compatibility (AWG#22-30) with highly reliable double IDC termination
- Handling stacked connectors as a block offers easy mating and unmating
- Wiremount connector can be unplugged by gripping the center latch
- Fixed tabs prevent lifting and secure fixation of the board during soldering



3M™ Mini Stack Connector Wiremount Socket



3M™ Mini Stack Connector Junction Header



3M™ Mini Stack Connector Dust Cover



3M™ Mini Stack Connector Boardmount Header

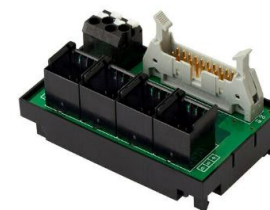

3M™ Mini Stack Connector Interface Unit



3M™ Ministack Connector Hand Tool

## Termination Process

### Work Steps

Crimp Connector 3pins	
• Strip wire	x3
• Set terminal in tool	x3
• Set wire and crimp terminal	x3
• Insert terminated wire into housing	x3

Total 12 steps

3M™ Mini Stack Connector 3pins	
• Set connector into tool	x1
• Set wires into tool and crimp terminals simultaneously	x1
• Insert terminated wires into housing simultaneously	x1

Total 3 steps

### Work Time

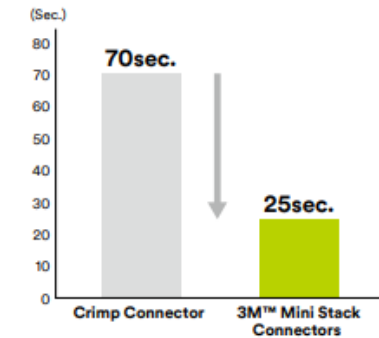

[Boardmount Connector Product Page](#)

[Wiremount Connector Product Page](#)

# 3M Industrial Cable Portfolio

# 3M™ Round Conductor Flat Cable

## Cable feature options:

Cost effective cable

- Pitch: 0.100”, 0.05”, 1mm and 0.025”
- Conductor stranding: solid or stranded
- Conductor color: gray, dark gray, black, opaque white
- Conductor Insulation: PVC, TPE, FEP, LSHF EVA/PO or Halogen Free
- Flex: 1 million, 10 million or 100 million flex cycles
- Zippable for branching or discrete termination

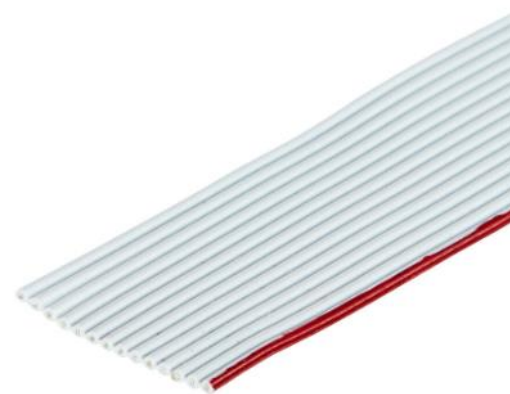

Basic

Color coded

Jacketed

Cross talk protection

EMI protection options

# 3M™ Color Coded Flat Cable

## Cable feature options:

Cost effective cable with multiple color conductor

- Pitch: 0.05”
- Conductor stranding: stranded
- Conductor size: 26 and 28 AWG
- Conductor color: 10 color repeat
- Conductor Insulation: PVC
- Zippable for branching or discrete termination



Basic

Color coded

Jacketed

Cross talk protection

EMI protection options

[Color Coded Flat Cable, 3811 Series Product Page](#) (26 AWG)

[Color Coded Flat Cable, 3302 Series Product Page](#) (28 AWG)

# 3M™ Twisted Pair Flat Cable

## Cable feature options:

Twisted Pairs reduces crosstalk for balanced applications

- Pitch: 0.05”
- Conductor stranding: Stranded
- Conductor size: 28 AWG
- Conductor color: Blue/White or 10 color repeat
- Conductor Insulation: PVC or Halogen Free

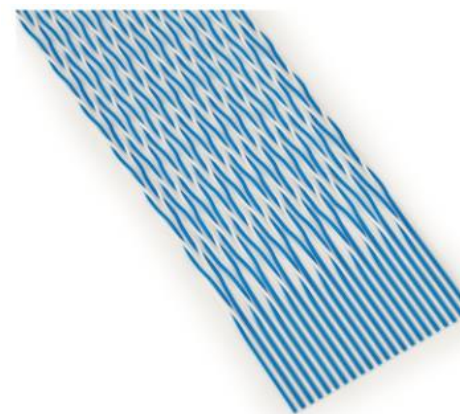

Basic



Color coded



Jacketed



Cross talk protection



EMI protection options



[Twisted Pair Flat Cable, 1700 Series Product Page \(PVC\)](#)

[Twisted Pair Flat Cable, HF100 Series Product Page \(Halogen Free\)](#)

# 3M™ Jacketed Flat Ribbon Cable

## Cable feature options:

Jacket provides protection from environmental damage

Shielding provides protection against EMI

- Pitch: 0.05”, 1 mm and 0.025”
- Conductor stranding: Solid or Stranded
- Conductor size: 28 and 30 AWG
- Conductor color: Gray, dark gray translucent, Silver,
- Conductor Insulation: PVC, TPE, Polyolefin, or Halogen Free
- Shielding: None, Cu Braid, Pleated Cu Foil, Expanded Cu, Al Foil

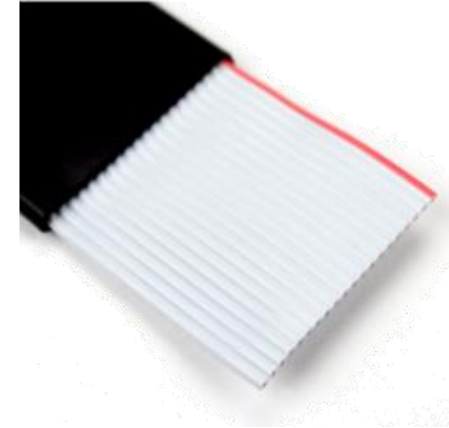

Basic

Color coded

Jacketed

Cross talk protection

EMI protection options



# 3M™ Round Jacketed Flat Cable

## Cable feature options:

Jacket provides protection from environmental damage

Shielding provides protection against EMI

- Pitch: 0.05” and 0.025”
- Conductor stranding: Stranded
- Conductor size: 26, 28 and 30 AWG
- Conductor color: Gray, dark gray
- Conductor Insulation: PVC or PO
- Shielding: None, Cu Braid or Al Foil/Cu Braid

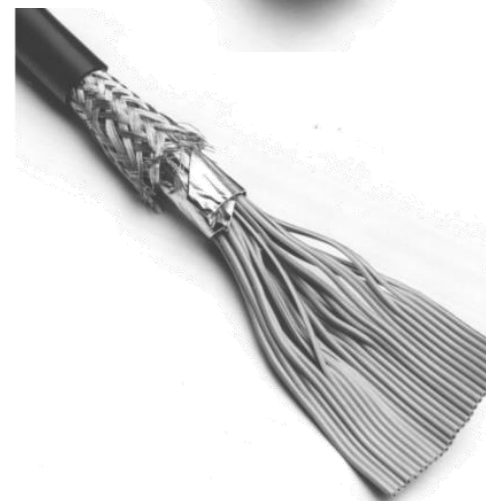

Basic



Color coded



Jacketed



Cross talk protection



EMI protection options



# 3M™ Twisted Pair Round Jacketed Cable

## Cable feature options:

Jacket provides protection from environmental damage

Shielding provides protection against EMI

Twisted Pairs reduces crosstalk for balanced applications

- Pitch: 0.05” and 0.025”
- Conductor stranding: Stranded
- Conductor size: 26, and 28 AWG
- Conductor color: Color Coded
- Conductor Insulation: PVC or Halogen Free
- Shielding: None, Cu Braid or Al Foil/Cu Braid



Basic



Color coded



Jacketed



Cross talk protection



EMI protection options



# 3M™ Input/Output Connectors

# 3M™ D Sub Connectors

# 3M™ D Sub Connectors

## Key Features:

- Available in either open or closed end cover
- Available with dimples to aid in EMI/ESD protection
- Improved metal strain relief hooks directly to metal shell
- Low profile
- Four mounting options
- Position options: 09, 15, 25, 37 & 50
- RoHS compliant

## Applications/Wins:

- IDC termination over solder cup – labor savings, mass terminations

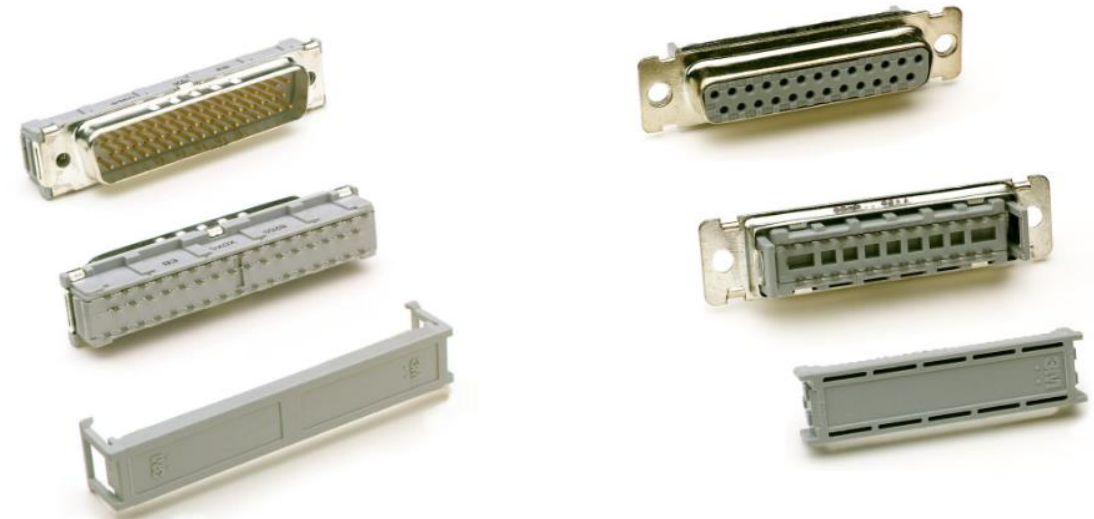

Plug (50 position)

Socket (25 position)

[3M™ D Sub Plug, 8200 Series Product Page](#) (09, 15, 25 & 37 position plug)

[3M™ D Sub Plug, 8250 Series Product Page](#) (50 position plug)

[3M™ D Sub Socket, 8300 Series Product Page](#) (09, 15, 25 & 37 position socket)

[3M™ D Sub Socket, 8350 Series Product Page](#) (50 position socket)

# 3M™ Mini Delta Ribbon (MDR) Cable Components

# 3M™ MDR Connector Selection Guide

## MDR Selection Guide

3M Interconnect Products

# MDR Connector Selection Guide

**3M™ Mini Delta Ribbon (MDR) System for I/O Applications, 0.050" x 0.050"**

	Wiremount Connectors			Boardmount Plug Connectors			Specialties
	IDC Wiremount Plug, Shielded	Solder Plug, Shielded	Non-Shielded IDC Plug	IDC Wiremount Receptacle	Straddlemount Plug	Through-Hole Plug, Right Angle, Shielded	Through-Hole Plug, Straight
Pincount	14 20 26 36 40	10114-6000 EC 10120-6000 EC 10126-6000 EC 10136-6000 EC 10140-6000 EC	10114-3000 PC (PE) 10120-3000 PC (PE) 10126-3000 PC (PE) 10136-3000 PC (PE) 10140-3000 PC (PE)		10220-0210 EC 10226-0210 EC 10236-0210 EC 10240-0210 EC	10126-x2y2 PC 10126-x2y2 PC 10136-x2y2 PC	
	50 68 72 80 100	10150-6000 EC 10168-6000 EC 10180-6000 EC 101A0-6000 EC	10150-3000 PC (PE) 10168-3000 PC (PE) 10180-3000 PC (PE) 101A0-3000 PC (PE)	10150-8x00 EE 10268-8x00 EE	10250-0210 EC 10268-0210 EC	10150-x2y2 PC 10150-x2y2 PC	10150-4CZ3 PL 101A0-4CZ3 PL
	136 200						
		Wire Accommodation: x = 0 Black Cover; 28 AWG Stranded, 30 AWG Solid (Standard) x = 1 Gray Cover; 26 AWG Solid (Available in 68 Contact only)  Assembly Press 10960 Handtool 3829		x = 0 with Strain Relief (Standard) x = 1 without Strain Relief (Special Order)	PC = 30µm (0.76 µm) Gold PL = 8µm Flash Gold  x = - A = Compatible Board thickness 1 mm (Standard) O = 1.6 mm (Special Order)  Solder Tail-Gold Flash	x = 5 normal type Panel/Board Retention Feature y = - 1 = M2.5 panel/M2.5 screw lock B = M2.5 panel/ground lock 4 = # 4-40 panel/4-40 screw lock E = # 4-40 panel/ ground lock	
Plating/Wiping Area	30µm (0.76 µm) Gold PE = 20µm (0.50 µm) Gold	PC = 30µm (0.76 µm) Gold PE = 20µm (0.50 µm) Gold	30µm (0.76 µm) Gold	30µm (0.76 µm) Gold	30µm (0.76 µm) Gold 8µm (0.20 µm) Gold	30µm (0.76 µm) Gold	8µm (0.20 µm) Gold
UL File	E68080	E68080	E68080	E68080	E68080	E68080	UL 94V-0
UL Flammability	UL 94V-0	UL 94V-0	UL 94V-0	UL 94V-0	UL 94V-0	UL 94V-0	UL 94V-0
Temp. Range	-20°C to +85°C	-55°C to +105°C	-20°C to +85°C	-20°C to +85°C	-20°C to +85°C	-20°C to +85°C	-20°C to +85°C
*RoHS Compliant	Yes	Yes	Yes	Yes	Yes	Yes	Yes
Tech Sheet No.	TS-0423	TS-0669	TS-0514	TS-0425	TS-0698	TS-0620	TS-0716

**3M™ MDR Hand Tool Kit 3829**

For the assembly of 3M™ MDR Wiremount Plug 101xx-60x0 (14-68 pos) Series onto 3M™ Round Jacketed Discrete Wire Cables (e.g. Series 3600, 3647, KU-C-).

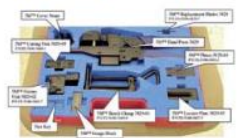

**3M™ MDR Assembly Press 10960**

For the assembly of the 3M™ MDR Wiremount Plug 101XX-60x0 (14-100 pos) Series onto 3M™ Round Jacketed Discrete Wire Cables (e.g. Series 3600, 3647, KU-C-).

- Accessories:**
- 10960-2000 Hand Press
  - 10961 Cutting Unit, includes 2 spare blades (10970-9)
  - 10962-2000 Fixture Unit, includes 14, 20, 26, 36, 40, 50, 68, 80 and 100 position connector stops
  - 10964-1 Cable Clamp, Black, 14-50 position
  - 10964-2 Cable Clamp, Silver, 66-100 position



## High Density Input/Output Connectors

### 3M™ Mini Delta Ribbon (MDR) Connectors

Performance and Reliability in Miniature  
The Mini Delta Ribbon (MDR) is a half pitch interconnect system from 3M, designed to meet the needs of high speed/density input/output applications. With more than 20 years on the market, the MDR system is an established and well-proven solution for high density I/O.

- MDR enjoys widespread acceptance by offering a combination of design features:
- Shielded shells provide EM/ESD protection
  - Pre-loaded ribbon contacts provide proven reliable connection
  - IDC U-shaped contacts allow mass termination
  - Wide range of pin counts and form factors enable design flexibility

As one of the world's most innovative companies, 3M is continually developing its products to meet your I/O needs. The current range of MDR system components can easily be expanded to meet the specific requirements of a broad range of applications. The MDR connector system contains a ribbon-style contact based on a 0.050" centerlines. Both the receptacle and the mating plug contain pre-loaded contacts for reliable contact during insertion and withdrawal cycles. The cable connectors utilize an insulation stripping U-contact to connect to the cable conductor wires. The contact is stamped from a high performance copper alloy, which provides an excellent combination of mechanical strength, electrical conductivity and corrosion resistance.

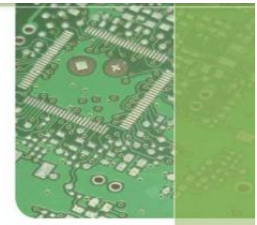

**Dedicated 3M™ Cables for Series 101xx-60x0 EC**

Cable Type/Description	Round Shielded Jacketed Discrete Wire Cable	Round Shielded Jacketed Discrete Wire Cable	Round Shielded Jacketed Discrete Wire Cable	Plated Foil Shielded Discrete Wire Cable
<b>3M Cable Series</b>	<b>3600B</b>	<b>3644B</b>	<b>KU-C-KMPVV</b>	<b>90101</b>
<b>Features</b>	- Twisted pairs - Dual shielding - 35 db average shielding effectiveness - Reduced crosstalk - CL2 listed for external use - Wire OD balanced for use with MDR	- Twisted pairs - Dual shielding - 35 db average shielding effectiveness - Reduced crosstalk - Suitable for 100 Ohm balanced impedance applications - CL2 listed for external use - Wire OD balanced for use with MDR	- Twisted pairs - Reduced crosstalk - Very flexible	- Thick jacket for external applications - Suitable for 50 Ohm unbalanced and 100 Ohm balanced impedance applications - 35 db average shielding effectiveness - Very low crosstalk - CL2 listed for external use
<b>Conductor Size</b>	28 AWG	28 AWG	28 AWG	30 AWG
<b>Conductor Material</b>	Tinned Copper	Tinned Copper	Tinned Copper	Tinned Copper
<b>Conductor Stranding</b>	7 x 0.127 (7/38)	7 x 0.127 (7/38)	7 x 0.127 (7/38)	Solid
<b>Conductor Quantity</b>	2 to 100 (1 x 50 Pairs)	14 to 100 (7 x 50 Pairs)	14 to 100 (7 to 50 Pairs)	20 to 100
<b>Primary Insulation</b>	PVC	Polyolefin	PVC	TFE
<b>Primary Color</b>	Color Coded	Color Coded	Color Coded	Translucent
<b>Jacket Insulation</b>	PVC	Color Coded	PVC	PVC
<b>Jacket Color</b>	Beige (Black optional)	Beige (Black optional)	Cream	Gray
<b>Shield</b>	Aluminum Foil + Copper Braid	Aluminum Foil + Copper Braid	Tinned Copper Braid	Plated Copper Foil
<b>Voltage Rating USA / EU (V)</b>	N.E.C. 725, CL2 / -50	N.E.C. 725, CL2 / -50	30 / -50	N.E.C. 725, CL2 / -50
<b>Temperature Min. (°C)</b>	-30	-30	-30	-30
<b>Temperature Max. (°C)</b>	+75	+75	+60	+75
<b>UL Recognition / Listing</b>	- / ✓	- / ✓	- / ✓	✓ / ✓
<b>Flammability UL / IEC</b>	N.E.C. 725, CL2 / FT1	N.E.C. 725, CL2 / FT1	N.E.C. 725, CL2 / FT1	N.E.C. 725, CL2 / FT1
<b>RoHS compliant</b>	✓	✓	✓	✓
<b>Download by Tech Sheet Number</b>	TS-0388	TS-0626	TS-2272	TS-0285
<b>3M.com/interconnects</b>	TS-0388	TS-0626	TS-2272	TS-0285

# 3M™ Mini Delta Ribbon (MDR) I/O-Interface

## Key Features:

- I/O connector and assembly platform
- Industry-proven interface
- Excellent electrical and EMI / ESD characteristics
- Camera Link™ standard compliant Ribbon contact design is highly reliable for mating and un-mating

## Markets:

Machine Vision, Inspection, LVDS, Medical, Surveillance, Communication Systems, Imaging Systems, Instrumentation, Baggage scanning, MRI equipment

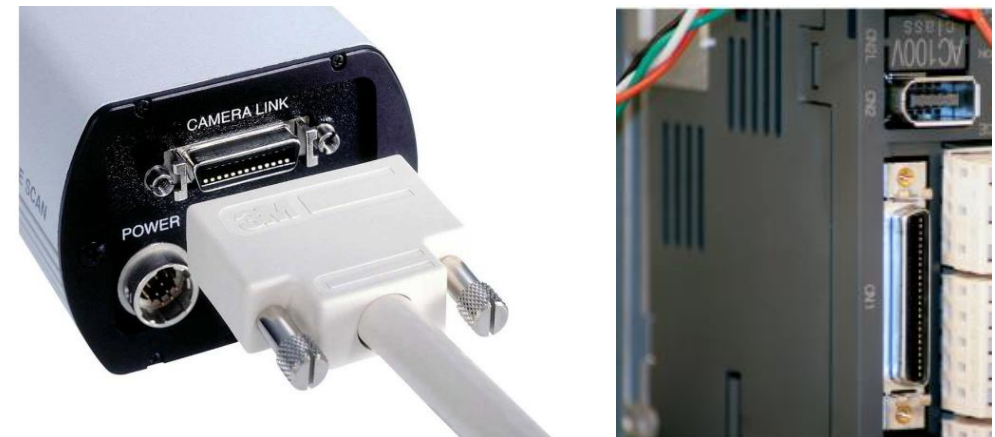



# 3M™ Mini Delta Ribbon (MDR), 101XX-3000PX, 101 Series

[Back to index](#)

## Key Features:

- Wiper-on-wiper contact for reliable repetitive plugging
- Solder cup termination requires no special tooling
- Accepts a wide variety of discrete wire (24 to 30 AWG) cable construction
- Contacts: 14, 20, 26, 36, 40 and 50



# 3M™ Mini Delta Ribbon (MDR), 101XX-60XOEC, 101 Series

[Back to index](#)

## Key Features:

- Wiper-on-wiper contact for reliable repetitive plugging
- MDR digital LCD interface as a 20 or 26 contact connector
- IEEE 1284C Interface as a 36-contact connector
- Accepts a wide variety of cable constructions including flat, round, twisted pair and twinax cables
- Wiremount plug, IDC, Shielded
- Contacts: 14, 20, 26, 36, 40, 50, 68, 80 and 100



# 3M™ Mini Delta Ribbon (MDR), 101 Series

## Other options:

- Wiper-on-wiper contact for reliable repetitive plugging
- Boardmount, straddlemount or wiremount
- Screw and ground lock
- Solder tails



3M™ Mini Delta Ribbon (MDR),  
101XX-8X00EE, 101 Series



3M™ Mini Delta Ribbon (MDR),  
101XX-X2X2XC, 101 Series



3M™ Mini Delta Ribbon (MDR),  
101XX-4CZ3 PL, 101 Series



3M™ Mini Delta Ribbon (MDR)  
101XX-900AXX 101 Series

# 3M™ Mini Delta Ribbon (MDR), 102XX-1020EC, 102 Series

[Back to index](#)

## Key Features:

- Wiper-on-wiper contact for reliable repetitive plugging
- IEEE 1284C Interface as a 36-contact connector
- Interface latch design for connection stability
- Accepts a wide variety of cable constructions including flat, shielded flat and twisted pair cables
- Contacts: 20, 26, 36, 40, 50 and 68
- RoHS compliant and UL94V-0



# 3M™ Mini Delta Ribbon (MDR), N102XX-52XXXC, 102 Series

[Back to index](#)

## Key Features:

- Boardmount receptacle
- Wiper-on-wiper contact for reliable repetitive plugging
- Rugged die cast metal case construction
- SMT compatible PCT insulator material
- Screw or ground lock for reliable PCB retention
- Interface latch design for connection stability
- IEEE 1284C Interface as a 36 contact connector
- Contacts: 14, 20, 26, 36, 40, 50, 68, 80 and 100

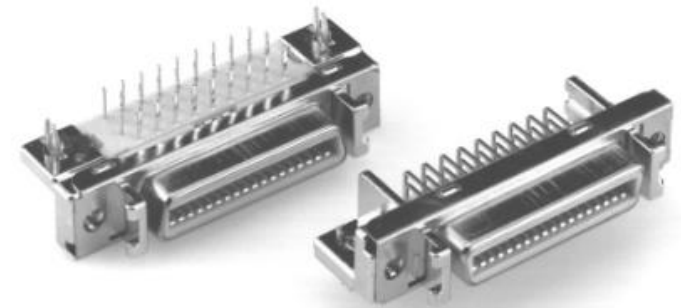

# 3M™ Mini Delta Ribbon (MDR), 102 Series

## Other options:

- Wiper-on-wiper contact for reliable repetitive plugging
- Boardmount, panelmount, wiremount
- Screw and ground lock
- Solder tails and press fit



3M™ Mini Delta Ribbon (MDR),  
10268-5JBEPC, 102 Series



3M™ Mini Delta Ribbon (MDR)  
Connectors, 102 Series



3M™ Mini Delta Ribbon (MDR),  
102XX-M218XE, 102 Series



3M™ Mini Delta Ribbon (MDR)  
Connectors, 102 Series



3M™ Mini Delta Ribbon (MDR),  
102XX-R2XXS, 102 Series



3M™ Mini Delta Ribbon (MDR)  
Connectors, 102 Series



3M™ Mini Delta Ribbon (MDR),  
102XX-22X0XE, 102 Series



3M™ Mini Delta Ribbon (MDR)  
Connectors, 102 Series

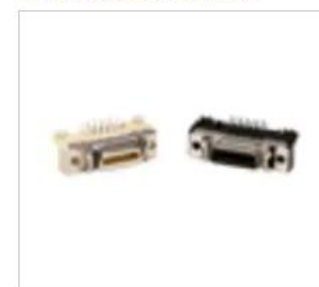

3M™ Mini Delta Ribbon (MDR),  
X102XX-55X3XX, 102 Series



3M™ Mini Delta Ribbon (MDR)  
Connectors, 102 Series

# 3M™ Mini Delta Ribbon (MDR) Junction Shell, 103 Series (Shell)

[Back to index](#)

## Available options:

- Rugged metal or plastic
- Strain relief
- EMI/ESD protection
- Quick release latching
- Straight or 60° exit
- RoHS compliant



3M™ Mini Delta Ribbon (MDR) Junction Shell 103XX-52F0-008



3M™ Mini Delta Ribbon (MDR), 103XX-C200-00, 103 Series



3M™ Mini Delta Ribbon (MDR) Junction Shell 103XX-3280-000-X



3M™ Mini Delta Ribbon (MDR) Junction Shell 103XX-1230-00



3M™ Mini Delta Ribbon (MDR), 103XX-C500-00, 103 Series



3M™ Mini Delta Ribbon (MDR) Connectors, 103 Series



3M™ Mini Delta Ribbon (MDR) Junction Shell 103XX-12R1-00



3M™ Mini Delta Ribbon (MDR) Junction Shell 103XX-3210-00X

# 3M™ Shrunk Delta Ribbon (SDR) Connectors



# 3M™ Shrunk Delta Ribbon (SDR) Connectors

## Key Features:

- Wiper on wiper contact for reliable repetitive mating
- Full metal face for better EMI shielding effectiveness
- On-board jacksockets maintains a secure connection
- Screw lock option
- Option: Ground lock for reliable PCB retention

## Applications/Wins:

- Camera Link applications



3M™ Shrunk Delta Ribbon (SDR)  
Connectors, 122XX-8250-00FR,  
122 Series



3M™ Shrunk Delta Ribbon (SDR)  
Connectors, 122XX-5150-00FR,  
122 Series



3M™ Shrunk Delta Ribbon (SDR)  
Connectors, 122XX-1150-00FR,  
122 Series

[122XX-1150-00FR Series Product Page](#) (Boardmount Straight)

[122XX-5150-00FR Series Product Page](#) (Boardmount Right Angle)

[122XX-8250-00FR Series Product Page](#) (Surfacemount)

# 3M™ Shielded Compact Ribbon (SCR) Connectors

# 3M™ SCR Connectors, Series 361

## Key Features:

- Polarized to provide proper cable insertion
- Robust ribbon style contact for reliable, repetitive plugging
- 360° shielding for excellent EMI protection
- 10 contacts can carry signal or power (up to one ampere per pin)
- Vibration resistant
- Solder termination for quick assembly with no dedicated tooling

## Applications/Wins:

- Basic power and signal I/O in a unique form factor
- Mistake proofing (Error prevention)

- [36110-3000XX Series Product Page](#) (Wiremount Plug)
- [36110-1110XX Series Product Page](#) (Boardmount Straight Plug)
- [36110-2220XX Series Product Page](#) (Boardmount Right Angle Plug)
- [36310-F200-008 Series Product Page](#) (Shell Kit - Wiremount Plug)



3M™ Shielded Compact Ribbon (SCR) Connectors, 361 Series (Wiremount)



3M™ Shielded Compact Ribbon (SCR) Connectors, 361 Series (Shell Kit – Wiremount plug)



3M™ Shielded Compact Ribbon (SCR) Connectors, 361 Series (Boardmount R/A)



3M™ Shielded Compact Ribbon (SCR) Connectors, 361 Series (Boardmount Straight)

# 3M™ SCR Connectors, Series 362

## Key Features:

- Mates to all 3M™ Shielded Compact Ribbon (SCR) Boardmount and Wiremount Plugs
- Polarized to provide proper insertion
- Robust ribbon style contact for reliable, repetitive plugging
- 10 contacts can carry signal or power (up to one ampere per pin)
- Vibration resistant
- Solder termination for quick assembly with no dedicated tooling
- Accommodates up to 18 AWG wire



3M™ Shielded Compact Ribbon (SCR) Connectors, 362 Series (Wiremount Plug)

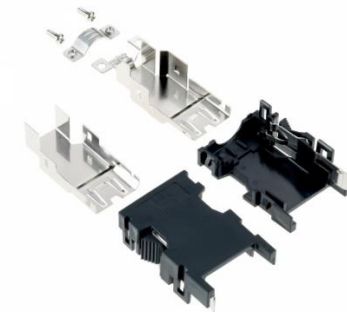

3M™ Shielded Compact Ribbon (SCR) Connectors, 363 Series (Shell Kit – Wiremount plug)

[36210-0100XX Series Product Page](#) (Wiremount Receptacle)

[36310-3200-008 Series Product Page](#) (Shell Kit - Wiremount Receptacle)

# 3M™ 2mm IEEE 1394 Connectors

# 3M™ 2mm IEEE1394 , Series 3E106

## Key Features:

- Robust ribbon style contact for reliable, repetitive plugging
- Body tabs provide lateral support to solder joints and help enable shield grounding
- 360° shielding for excellent EMI protection
- Six contacts can carry signal or power (up to one amp per pin)
- Polarized to provide proper cable insertion

## Applications/Wins:

- Firewire
- Competitors exiting the business

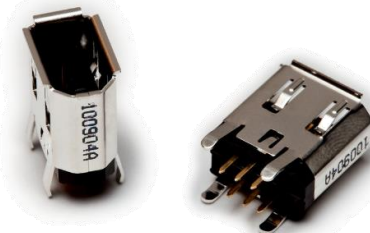

3M™ I/O Interconnect System 2.0 mm for IEEE 1394 3E106 Series (Boardmount Straight Plug)

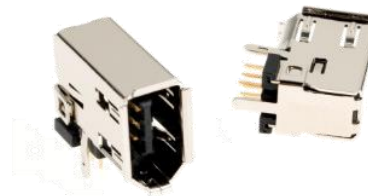

3M™ I/O Interconnect System 2.0 mm for IEEE 1394 3E106 Series (Boardmount Right Angle, Upright Plug)



3M™ I/O Interconnect System 2.0 mm for IEEE 1394 3E106 Series (Boardmount Right Angle, Horizontal Plug)

[3E106-1230 KV Product Page](#)

[3E106-22X0XX Product Page](#)

[3E106-0220XX Product Page](#)

(Boardmount Straight Plug)

(Boardmount Right Angle, Upright Plug)

(Boardmount Right Angle, Horizontal Plug)

# 3M™ 2mm IEEE1394 , Series 3E206

## Key Features:

- Designed to mate to all 3M I/O Interconnect System 2.0 mm for IEEE 1394 Boardmount Plugs
- Polarized to provide proper insertion
- Robust ribbon style contact for reliable, repetitive plugging
- Six Contacts can carry signal or power (up to one amp per pin)
- Vibration resistant (Snap latch shell)
- Solder termination for quick assembly with no dedicated tooling
- Accommodates up to AWG 18 wire



3M™ I/O Interconnect System 2.0 mm for IEEE 1394, 3E206 Series (Wiremount Receptacle)

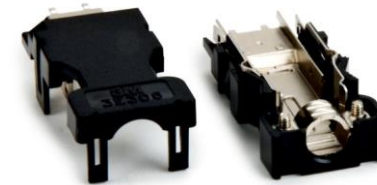

3M™ I/O Interconnect System 2.0 mm for IEEE 1394 3E306 Series (Shell Kit - Wiremount Receptacle)

[3E206-0100XX Product Page](#)

[3E306-3200-008 Product Page](#)

(Wiremount Receptacle)

(Shell Kit – Wiremount Receptacle)

# 3M™ Memory Card Headers



# 3M™ Memory Card Connectors

## Options:

1. MicroSD™
2. CFast™
3. CompactFlash™

## Applications/Wins:

- Competitors exiting the business



3M™ Card Connector  
microSD™



3M™ Ejector for  
CFast™, 7G24 Series



3M™ Connector for  
CFast™, 7G24 Series



3M™ CF Card Header,  
7E50 Series (Type I)



3M™ CF Card Header,  
7E50 Series (Type II)

# 3M Cable Assemblies

# 3M™ Molded Assemblies

# 3M™ Molded Assembly, 1M & 2M Series

## Key Features:

- One-piece design shields against elements
- Excellent for robust long-term connections in high-vibration environments
- Available in multiple pin counts and orientations for versatility
- Cables are available for use in high flex applications
- Molded-in strain relief creates low height profile for space savings
- PCB connector available

## Applications/Wins:

- Network and telecommunications
- Test and measurement
- Data processing equipment

[3M™ Molded Assembly 1M Product Page](#) (0.100"/2.54mm pitch)

[3M™ Molded Assembly 2M Product Page](#) (2mm pitch)

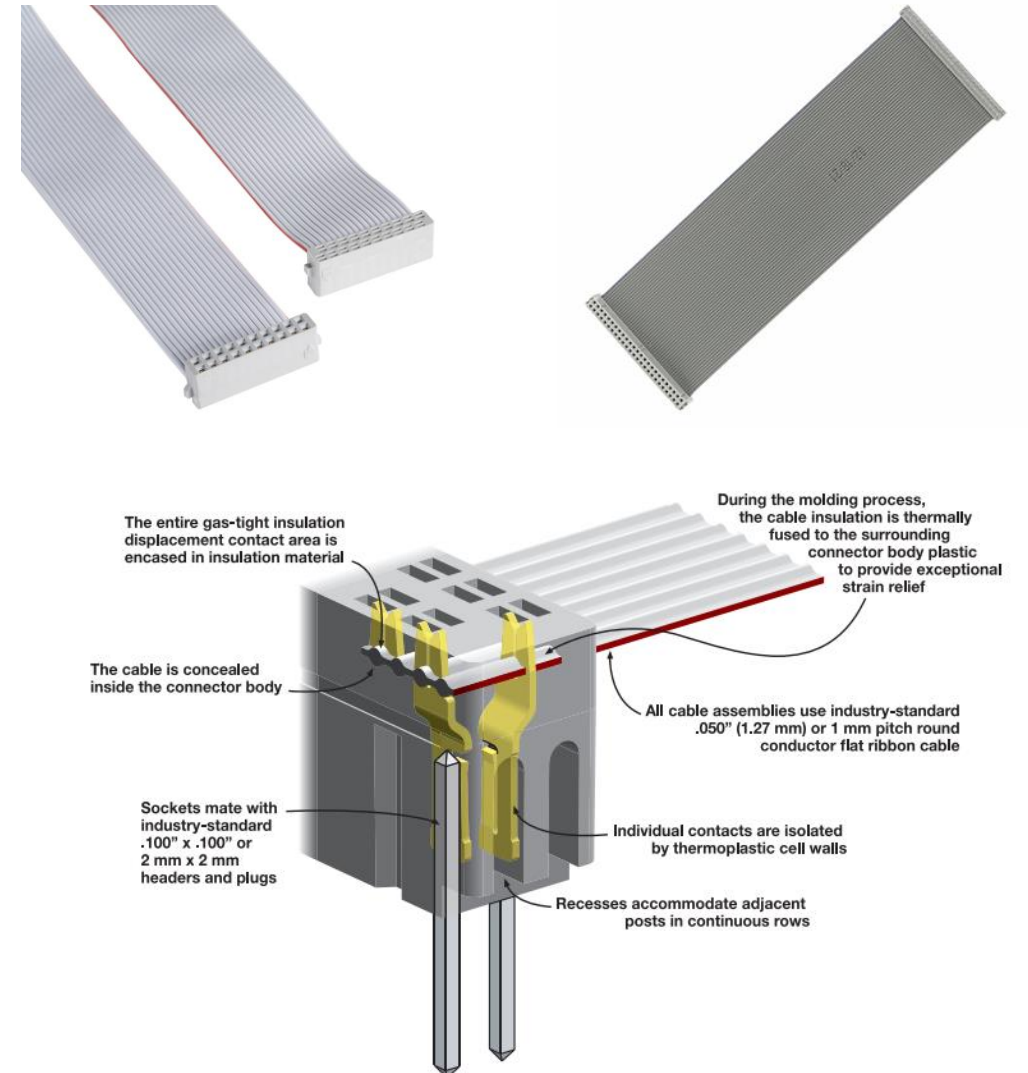

# 3M™ USB3 Vision Industrial Camera Cable Assembly

# 3M™ USB3 Vision Cable Assembly, 1U30A Series

## Key Features:

- Non-repetitive motion applications
- Excellent transmission up to at least 7m
- Flexible 6.2mm outside diameter cable for easy routing
- Straight, upward/downward, left-hand/right-hand configurations
- Reliable connection with locking screws available on USB3 and Micro B ends
- USB3.0 compatible
- RoHS2 and CE compliant

## Applications/Wins:

- Machine Vision



Functional cable length for  
1U30A series

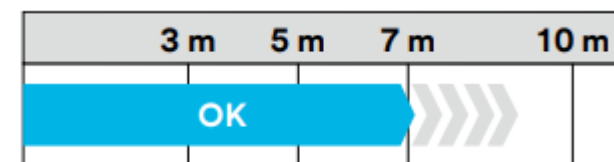

\*Tested in 3M test condition

# 3M™ USB3 Vision Cable Assembly, 1U30S Series

## Key Features:

- Excellent transmission characteristics enables >5M connection<sup>1</sup>
- Repeated bending durability >10million cycles<sup>2</sup>
- Reliable connection with locking screw (Available on USB3 and Micro B ends)
- Excellent U-shaped sliding durability and maintains same high transmission characteristics
- USB3.0 compatible
- USB3 Vision® compliant screw locking feature
- RoHS2 and CE compliant

1: Tested in 3M test condition; functionality >5M depends on camera/host combination

2: NO open/no significant degradation in electrical characteristics after 10 million cycles of R50 drag-chain bending

## Applications/Wins:

- Machine vision with repeated motion



Functional cable length for 1U30S series

3 m	5 m	7 m
OK	»»»	

\*Tested in 3M test condition

# 3M™ Mini Delta Ribbon (MDR) Cable Assemblies



# 3M™ Mini Delta Ribbon (MDR) Cable Assemblies (Transmission)

[Back to index](#)

## Key Features:

- Several shielded differential pairs (according to application)
- Supports VESA/DFP standard for 20-position MDR at host device
- LCD monitor assembly for Panel Link™/TMDS interface
- Supports LVDS FP Link, Flat Link™, Channel Link™, Panel Link™/TMDS electrical interfaces
- Each differential twin-ax pair has foil shield and drain wire
- Entire cable bundle is shielded with foil and braid for additional signal protection
- Rugged MDR ribbon type contact
- Quick release latches or thumbscrews
- RoHS\* compliant

## Applications/Wins:

- Solution for Digital Displays, Datacom and Telecom applications



[MDR Cable Assembly Product Page](#)

© 3M 2023. All Rights Reserved. 3M Confidential.



[MDR Selection Guide](#)

# 3M™ Mini Delta Ribbon (MDR) Cable Assemblies (Machine Vision)

[Back to index](#)

## Key Features:

- Supports the Automated Imaging Association's Camera Link Standard for industrial camera to frame grabber communications
- 11 shielded twisted pairs and four drain wires
- Entire cable bundle is shielded with foil and braid for additional signal protection
- Rugged MDR ribbon type contact
- Rugged thumbscrew retention
- EMI shielded junction shell in either plastic or overmolded construction
- RoHS\* compliant

## Applications/Wins:

- Camera Link, machine vision applications



# 3M™ Shrunk Delta Ribbon (SDR) Cable Assemblies

# 3M™ Shrunk Delta Ribbon (SDR) Cable Assemblies (Machine Vision)

[Back to index](#)

## Key Features:

- Supports AIA Industrial Mini Camera Link Standard for Mini C/L camera to frame grabber applications
- 11 shielded twisted pairs with four drain wires
- Entire cable bundle is shielded with foil and braid for additional signal protection
- Rugged ribbon contact type
- Rugged thumbscrew retention
- Available right angle overmolded SDR backshells eliminate bend radius
- EMI shielded cable assembly

## Applications/Wins:

- Mini Camera Link and Camera Link products



# 3M™ Internal Twin Axial Cable Assemblies

# 3M™ Twin Axial Cable Overview

**3M employs a unique precision-formed continuously laminated shield over entire cable, to deliver:**

- Precision and control
- Thinness & flexibility
- Tight folding/creasing virtually without loss of performance

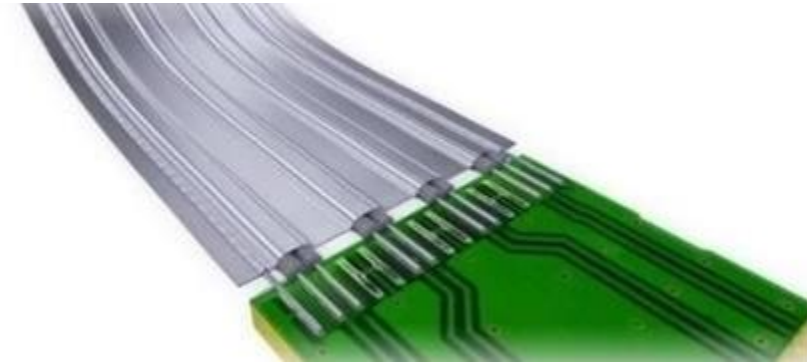

**Competition uses spiral/longitudinal wrapped shield around individual pairs, optionally further laminated together:**

- Thicker, less flexible
- Performance degrades in tight bends

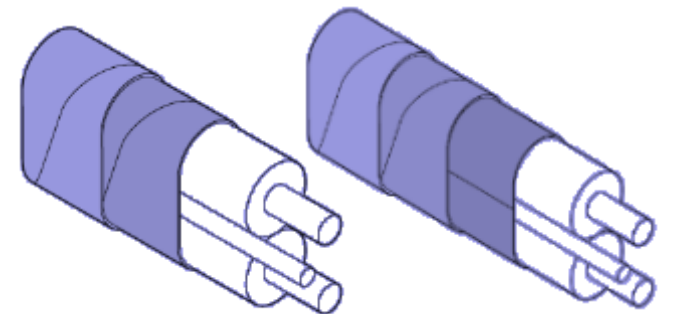

# 3M™ Internal Twin Axial Cable Assemblies

## Key Features:

- Routability enabled by:
  - High cable foldability
  - Low-profile (thin)
- Maintains Signal Integrity performance when folded
- Helps improved cable management
- Helps improved thermal management  
(better airflow in the system)





## Applications/Wins:

- High density system architectures
- Server
- PC Gaming
- High performance computing
- High performance test equipment

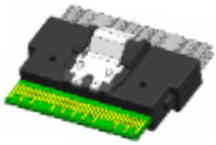
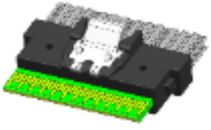

**In general, cables replace PCB traces to help  
reduce loss and cost**

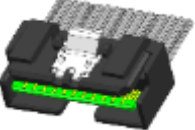
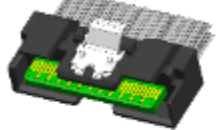
# 3M™ Internal Twin Axial Cable Assemblies

	3M™ SlimLine assembly	3M™ Mini-SlimLine assembly	3M™ Compact SlimLine assembly	3M™ Low Profile I/O assembly	3M™ Multi-Channel I/O assembly	3M™ Scalable High-Speed assembly	3M™ PCIe Extenders and Jumper assembly
							
# of Lanes	4, 6, 8 or 12	8, 12	8, 12	8, 12	8, 12	4, 8 or 16 (1C, 2C, or 4C)	8, 16
Protocol	SATA, SAS, PCIe®	SATA, SAS, PCIe®	SATA, SAS, PCIe®	SAS, PCIe®	SAS, PCIe®	SAS, PCIe®	PCIe®
Speeds	SAS 3.0: 12 Gbps PCIe® 4.0: 16 Gbps PCIe® 5.0: 32 Gbps	SAS 3.0: 12 Gbps PCIe® 4.0: 16 Gbps PCIe® 5.0: 32 Gbps	SAS 3.0: 12 Gbps PCIe® 4.0: 16 Gbps PCIe® 5.0: 32 Gbps	SAS 3.0: 12 Gbps PCIe® 4.0: 16 Gbps	SAS 4.0: 24 Gbps PCIe® 5.0: 32 Gbps	SAS 4.0: 24 Gbps PCIe® 5.0: 32 Gbps	PCIe® 3.0: 8 Gbps PCIe® 4.0: 16 Gbps PCIe® 5.0: 32 Gbps
Types of Application	Motherboard or controller to drive backplane	Motherboard or controller to drive backplane	Motherboard or controller to drive backplane	Motherboard or controller to drive backplane	Motherboard or controller to drive backplane, midboard	Motherboard or controller to drive backplane, midboard	Ext: Flexible “riser” Jmp: Motherboard to motherboard
Specification	SFF-8654	SFF-8654	SFF-8654	Industry compatible	SFF-TA-1016	SFF-TA-1020	PCIe® -CEM



# 3M™ External Twin Axial Cable Assemblies

# 3M™ External Twin Axial Cable Assemblies

## Key Features:

- Efficient routing of cables
- Virtually no min bend radius
- Maintains Signal Integrity performance when folded
- Helps improve thermal management (better airflow in the system)
- Requires less space in front of port
- Improved serviceability
- Space saving

## Applications/Wins:

- Server to switch
- Server to Storage
- Other high speed test equipment
- Top of rack to server



**Tight bends at the connector allowing for efficient routing in space constrained applications**

# 3M™ Twin Axial External Cable Assembly Portfolio

**3M™ 400G QSFP-DD Direct Attach Copper Cable Assemblies**



**3M™ 100G QSFP28 Direct Attach Copper Cable Assemblies**



**3M™ 100G QSFP28 Direct Attach Copper Cable Assemblies**



**3M™ 100G QSFP28 Direct Attach Copper Cable Assemblies**



**3M™ Twin Axial Cable Assemblies for QSFP+ Applications, 40GbE**



Additional products available in:

- 25G, 10G and miniSAS

1: Q28-Q28 cable assembly - Cable and PCB are halogen free  
 2: Q-2Q and Q-4S - Cable is halogen free, PCB is not halogen free, CL2 Flame Rated  
 3: QSFP-DD - 3.25meter meets 802.3cd, 3.50meter does not meet 802.3cd standard, however, passes COM

	3M™ 400G QSFP-DD Direct Attach Copper Cable Assemblies	3M™ 100G QSFP28 Direct Attach Copper Cable Assemblies	3M™ 100G QSFP28 Direct Attach Copper Cable Assemblies	3M™ 100G QSFP28 Direct Attach Copper Cable Assemblies	3M™ Twin Axial Cable Assemblies for QSFP+ Applications, 40GbE
<b>Form Factor</b>	QSFP-DD	QSFP28 Q28-Q28 <sup>1</sup>	QSFP28 Q28-1Q28 <sup>2</sup>	QSFP28 Q28-4SFP28 <sup>2</sup>	QSFP+
<b>Aggregate Data Rate</b>	400G	100G	100G	100G	40G
<b>Channel Data Rate</b>	56G/channel (8x50)	25G/channel (4x25)	25G/channel (4x25)	25G/channel (4x25)	10G/channel (4x10)
<b>Lengths</b>	30 AWG: 0.50 - 2.0 m 26 AWG <sup>3</sup> : 2.25 - 3.50 m	30 AWG: 0.5 to 2.0m 26 AWG: 2.0 to 4.0m	30 AWG: 0.5 to 2.0m 26 AWG: 2 to 4.0m	30 AWG: 0.5 to 2.0m 26 AWG: 3.0 to 4.0m	30 AWG: 0.25 to 3.0m
<b>Series</b>	9V	9QJ0, 9QH6, 9QN0, 9QM6	9SR-Bxx	9SR-Axx	9QA0
<b>Standards</b>	QSFP-DD MSA IEEE 802.3 cd	SFF-8436, 8661 8665, 8661, 8662 IEEE 802.3bj	SFF-8661, 8662, 8665 IEEE 802.3bj	SFF-8661- 8662, 8665, 8431 IEEE 802.3bj	SFF-8436 IEEE 802.3ba

# IMPORTANT NOTICE

**Safety Data Sheet:** Consult Safety Data Sheet before use.

**Regulatory:** For regulatory information about this product, contact your 3M representative.

**Technical Information:** The technical information, recommendations and other statements contained in this document are based upon tests or experience that 3M believes are reliable, but the accuracy or completeness of such information is not guaranteed.

**Product Use:** Many factors beyond 3M's control and uniquely within user's knowledge and control can affect the use and performance of a 3M product in a particular application. Given the variety of factors that can affect the use and performance of a 3M product, user is solely responsible for evaluating the 3M product and determining whether it is fit for a particular purpose and suitable for user's method of application.

**Warranty, Limited Remedy, and Disclaimer:** Unless a different warranty is specifically stated on the applicable 3M product packaging or product literature, 3M warrants that each 3M product meets the applicable 3M product specifications on the Certificate of Analysis, which is established when the product is manufactured and deemed commercially available and is provided at the time 3M ships the product. 3M MAKES NO OTHER WARRANTIES OR CONDITIONS, EXPRESS OR IMPLIED, INCLUDING, BUT NOT LIMITED TO, ANY IMPLIED WARRANTY OR CONDITION OF MERCHANTABILITY OR FITNESS FOR A PARTICULAR PURPOSE OR ANY IMPLIED WARRANTY OR CONDITION ARISING OUT OF A COURSE OF DEALING, CUSTOM, OR USAGE OF TRADE. If a 3M product does not conform to this warranty, then the sole and exclusive remedy is, at 3M's option, replacement or repair of the 3M product or refund of the purchase price.

**Limitation of Liability:** Except where prohibited by law, 3M will not be liable for any loss or damage arising from the 3M product, whether direct, indirect, special, incidental, or consequential, regardless of the legal or equitable theory asserted, including, but not limited to, warranty, contract, negligence, or strict liability.

**Disclaimer:** For industrial use only. Not intended, labeled or packaged for consumer sale or use.

## Electronics Materials Solutions Division

3M Center, Building 223-3S-32

St. Paul, MN 55144-1000

1-800-251-8634 phone

651-778-4244 fax

[www.3M.com/electronics](http://www.3M.com/electronics)

3M is a trademark of 3M Company.

Please recycle.

©3M 2023. All rights reserved.

**Thank you**