

TE CONNECTIVITY INDUSTRIAL PRODUCT PORTFOLIO

BOARD CONNECTIVITY



LUMAWISE LED Holders



LUMAWISE Endurance N Connectors



LUMAWISE Endurance S Connectors



AmbiMate MS4 Sensor Modules

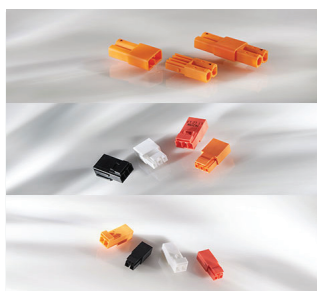

LIGHT-N-LOK Connectors



SlimSeal Miniature Connectors



BUCHANAN Wiremate Connectors

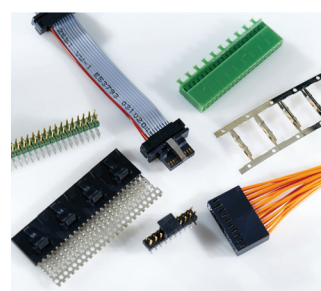

AMPMODU Connectors

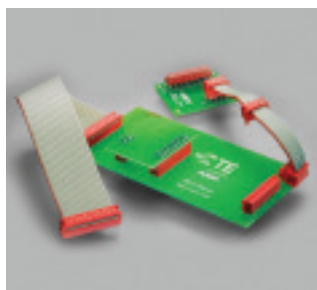

Micro-MaTch Connectors

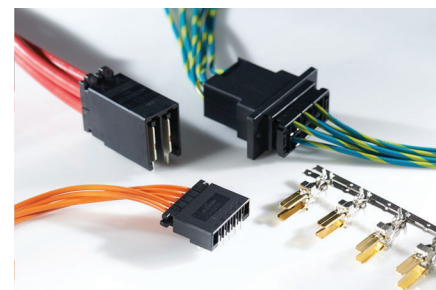

Dynamic Series

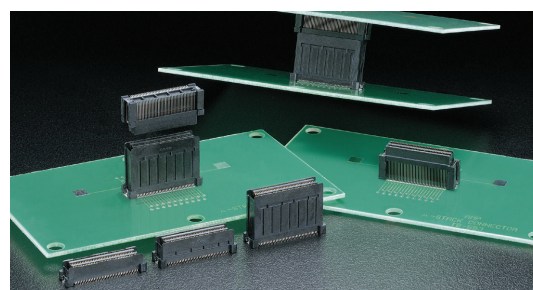

Micro Stack

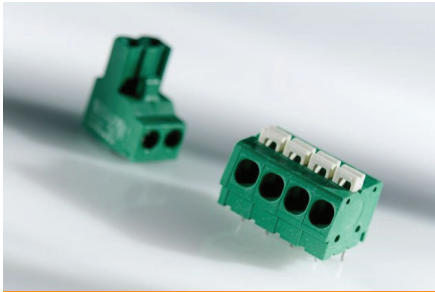

BUCHANAN Terminal Blocks

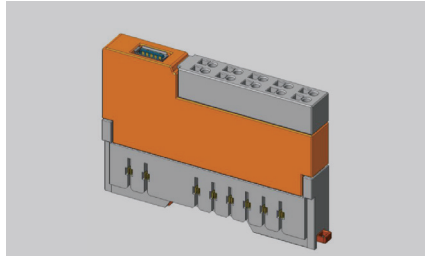

E-Mech Systems

RELAYS



Potter & Brumfield Solid State Relays

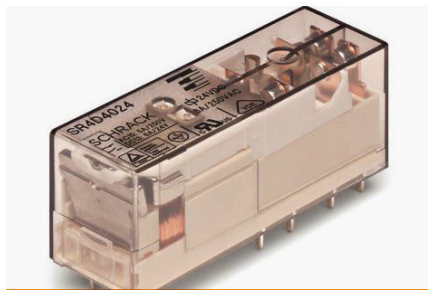

SCHRACK Force Guided Relays



Potter & Brumfield Circuit Breakers



Potter & Brumfield T9G Relays

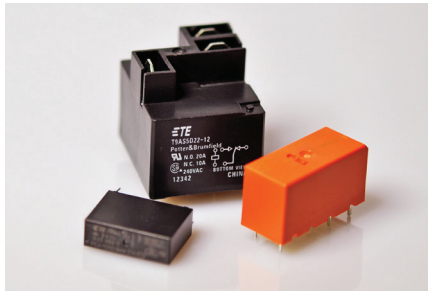

Power PCB Relays

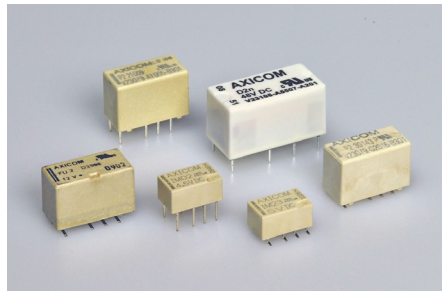

Axicom Signal Relays



IHV series

PRECISION POWER



CoolSplice Connectors



SOLARLOK Connectors



NECTOR Power Systems



Corcom Filters

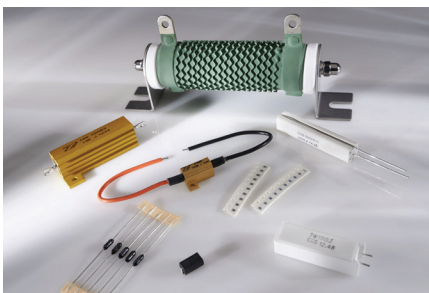

Passives



Switches



Circular Plastic Connectors

MOTION CONTROL & COMMUNICATION



MOTORMAN Hybrid Connectors



Micromotor Connectors



Magnet Wire Terminals



Resolvers

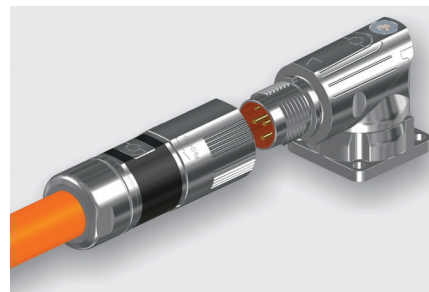

INTERCONTEC Connectors



Industrial USB Connectors

TE Connectivity Industrial Product Portfolio



Industrial M8/M12 Connectors

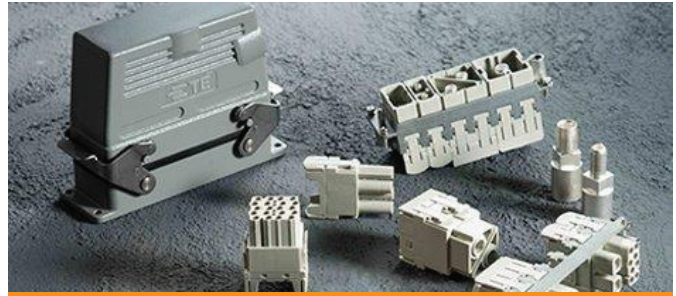

Heavy Duty Connectors



Industrial RJ45 Connectors



Industrial Mini I/O Connectors

ELECTRICAL



Identification & Labeling

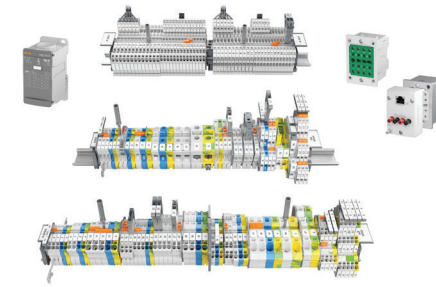

ENTRELEC

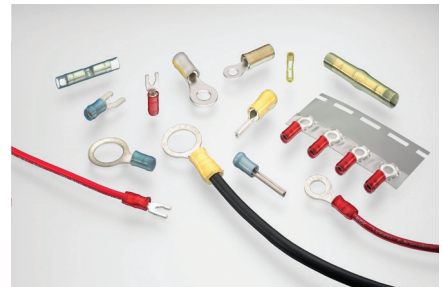

Terminals & Splices

RAIL

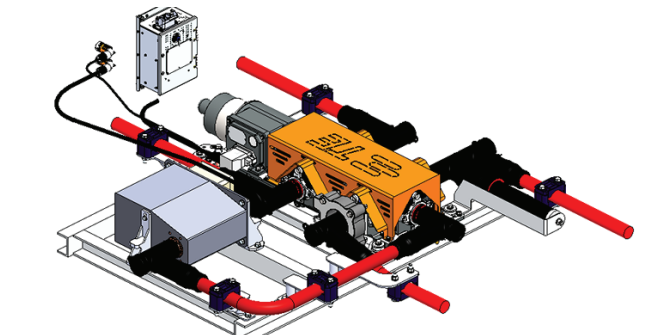

High Voltage Portfolio



Data Communications Portfolio

TE Connectivity Industrial Product Portfolio



Power and Signal Connectors

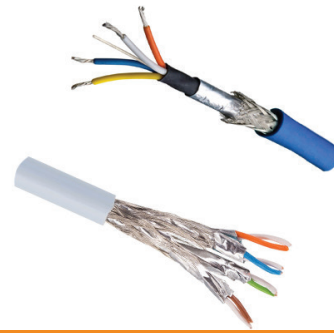

Rail Compliant Wire and Cable

CCAO

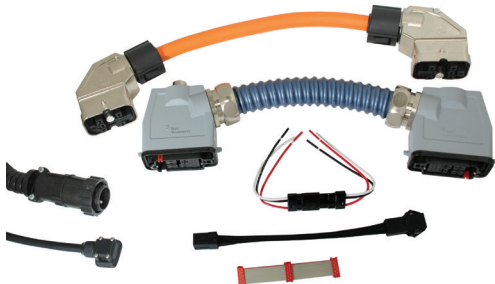

Cable Assemblies



Overmolded Cable Assemblies



Harnessing

APPLICATION TOOLING



Application Tooling



1-1773913-2 AK 02/20



© 2020 TE Connectivity. All Rights Reserved.
TE, TE Connectivity, TE connectivity (logo), LUMAWISE, LIGHT-N-LOK, BUCHANAN, AMPMODU, Micro-MaTch, Potter & Brumfield, SCHRACK, CoolSplice, SOLARLOK, MOTORMAN, INTERCONTEC, Corcom, NECTOR, Axicom and ENTRELEC are all trademarks.